

BISM

GRANDE

Watch Dive Computer

Operating Manual

FULL LCD

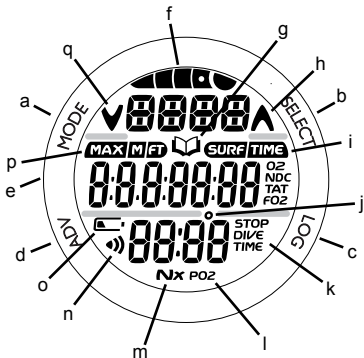

Components:

- a. Mode (M) Button
- b. Select (S) Button
- c. Light, Log (L) Button
- d. Advance (A) Button
- e. LED Warning Light
- f. Bar Graph
- g. Icon - Log Mode
- h. Icon - Ascend
- i. Icon - Surface Interval
 - O2 Time Remaining
 - No Deco Time Remaining
 - Total Ascent Time
 - FO2 Set Point
- j. Icon - Degrees
- k. Icon - Stop Time Required
 - Elapsed Dive Time
- l. Icon - PO2
- m. Icon - Nitrox
- n. Icon - Daily Alarm set
- o. Icon - Low Battery
- p. Icon - Depth/Max Depth
- q. Icon - Descend

CONTENTS

FULL LCD	2
NOTICES, DECOMPRESSION MODEL.....	7
INITIAL ACTIVATION.....	8
INTRODUCTION AND GENERAL FEATURES AND DISPLAYS	9
INTERACTIVE CONTROL CONSOLE.....	10
OPERATING MODE STRUCTURE	11
OPERATION AS A DIVE COMPUTER.....	12
PC INTERFACE.....	12
SYMBOLS AND ALPHA NUMERIC GRAPHICS	13
AUDIBLE ALARM.....	13
BACKLIGHT	15
POWER SUPPLY.....	16
WATCH FEATURES AND DISPLAYS	17
LOCAL DEFAULT TIME	18
MAIN TIME.....	19
SET MAIN TIME	20
ALTERNATE TIME.....	23
SET ALTERNATE TIME.....	24
COUNTDOWN TIMER	24
SET COUNTDOWN TIMER	25
CHRONOGRAPH.....	26
DAILY ALARM	28
SET DAILY ALARM	29
DIVE COMPUTER FEATURES AND DISPLAYS.....	31
BAR GRAPH.....	32
ALPHA / NUMERIC DISPLAYS	34
Depth Displays	34
Time and Date Displays.....	34
Temperature Display.....	35

CONTENTS (continued)

DIVE COMPUTER SURFACE SEQUENCE AND OPERATING MODES	37
DC OPERATING MODES	38
SURFACE MODE	38
NORM Surface Mode	40
NORM/GAUG SET MODES	42
Set F Group (FO2)	42
Setting FO2	44
Set FO2 50% Default	45
Set A Group (Alarms)	46
Set Audible Alarm	46
Set Depth Alarm	47
Set EDT (Elapsed Dive Time) Alarm	47
Set NIBG (Nitrogen Bar Graph) Alarm	48
Set DTR (Dive Time Remaining) Alarm	48
Set PO2 Alarm	49
Set U Group (Utilities)	50
Set Wet Activation	50
Set Units	51
Set Deep Stop	51
Set Safety Stop	52
Set Conservative Factor	53
Set Backlight Duration	53
Set Sampling Rate	54
SERIAL NUMBER	54
PLAN Mode	55
FLY Mode	57
DESAT Mode	58
LOG Mode	59
HISTORY Mode	64
DISPLAYED SYMBOLS AND ICONS	66

CONTENTS (continued)

OVERVIEW OF DIVE MODE INFORMATION	67
DIVE TIME REMAINING (DTR)	68
No Decompression DTR (NDC)	68
O2 DTR (OTR)	69
VARIABLE ASCENT RATE	70
ELAPSED DIVE TIME (EDT)	71
CONTROL OF DISPLAYS	71
WET ACTIVATION CONTACTS	72
NORM TYPE DIVE MODES	73
NORM NO DECOMPRESSION DIVE MODE	74
No Deco Deep Stop	76
No Deco Safety Stop	78
DECOMPRESSION DIVE MODE	79
VIOLATION MODES	81
Conditional Violation	81
Delayed Violation 1	82
Delayed Violation 2	82
Delayed Violation 3	83
Violation Gauge Mode	83
HIGH PO2	85
HIGH OXYGEN ACCUMULATION	86
NORM POST DIVE MODES	87
TRANSITION PERIOD	88
AFTER THE TRANSITION PERIOD	89
SUMMARY OF WARNING AND ALARM MESSAGES	90
GAUGE OPERATING MODE	91
GAUGE MODE	92

CONTENTS (continued)

FREE DIVE OPERATING MODE	95
FREE Surface Mode.....	96
FREE CDT (COUNTDOWN TIMER)	98
Set FREE CDT.....	99
FREE EDT (ELAPSED DIVE TIME) ALARM	100
Set FREE EDT Alarm.....	100
FREE DEPTH ALARMS (FDA)	101
Set FDA1.....	101
Set FDA2.....	102
Set FDA3.....	103
FREE DIVE MODE	104
FREE Dive CDT.....	104
FREE Dive Alarms.....	105
REFERENCE	107
CARE AND CLEANING	108
INSPECTIONS AND SERVICE	108
BATTERY REPLACEMENT	109
UPLOADING SETTINGS AND DOWNLOADING DATA	114
PC Compatibility Requirements.....	115
ERROR (RESET DURING A DIVE)	115
ALTITUDE SENSING AND ADJUSTMENT	116
No Decompression Limits at Altitude.....	117
OXYGEN EXPOSURE LIMITS	118
SPECIFICATIONS	119
INSPECTION / SERVICE RECORD	124



Pay special attention to items marked with this Warning symbol.

COPYRIGHT NOTICE

This operating manual is copyrighted, all rights are reserved. It may not, in whole or in part, be copied, photocopied, reproduced, translated, or reduced to any electronic medium or machine readable form without prior consent in writing from Bism/2002 Design.

Grande Operating Manual, Doc. No. 12-5308

© 2002 Design, 2012

San Leandro, CA USA 94577

TRADEMARK, TRADE NAME, AND SERVICE MARK NOTICE

Bism, the Bism logotype, Grande, the Grande logo are all trademarks, trade names, or service marks of Bism. All rights are reserved.

PATENT NOTICE

U.S. Patents have been issued, or applied for, to protect the following design features: Data Sensing and Processing Device (U.S. Patent no. 4,882,678), Ascent Rate Meter (U.S. Patent no. 5,156,055), other patents pending.

DECOMPRESSION MODEL

The programs within the Grande simulate the absorption of nitrogen into the body by using a mathematical model. This model is merely a way to apply a limited set of data to a large range of experiences. The Grande dive computer model is based upon the latest research and experiments in decompression theory. Still, using the Grande, just as using the U.S. Navy (or other) No Decompression Tables, is no guarantee of avoiding decompression sickness, i.e. "the bends." Every diver's physiology is different, and can even vary from day to day. No machine can predict how your body will react to a particular dive profile.

NOTICE

STORAGE and INITIAL ACTIVATION

Grande Watch/Dive Computers are placed in a Deep Sleep mode prior to being shipped from the factory. The intent is to extend storage life of the Battery for up to 7 years, before the unit is initially placed in service.

In this mode, Date and Time are updated as they normally would be. However, they are not displayed. Upon waking the Grande up, the correct Date and factory Time will be displayed and it will be ready to operate with full functions.

To wake the Grande up from Deep Sleep mode, simultaneously depress the upper/right (S) and lower/left (A) buttons for 2 to 3 seconds until the display comes full ON displaying the MAIN TIME screen, then release them.



NOTE: Once the Grande is brought out of the Deep Sleep mode, it can only be placed back in it by the factory.

INTRODUCTION
AND
GENERAL FEATURES AND DISPLAYS

INTRODUCTION

Welcome to Bism and thank you for choosing the Grande !

It is extremely important that you read this Operating Manual in sequence and understand it completely before attempting to use the Grande as a dive computer.

Remember that technology is no substitute for common sense, and a dive computer only provides the person using it with data, not the knowledge to use it.

INTERACTIVE CONTROL CONSOLE

The Interactive Control Console consists of four Control Buttons that allow you to select mode options and access specific information. They are also used to enter Settings, access Log and History modes, activate the Backlight, and acknowledge the Audible Alarm.

Throughout this manual they will be referred to as the M, S, L, and A buttons.

- Upper/Left - Mode (M) button
- Upper/Right - Select (S) button
- Lower/Right - Light, Log (L) button
- Lower/Left - Advance (A) button

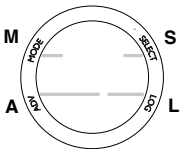

OPERATING MODE STRUCTURE

Unless it is operating in Dive Computer mode, the Grande will be ON in the default WATCH MAIN TIME (home time) mode (Fig. 1), like a standard WATCH, until the Mode is changed.

The M button is used to access 4 other Modes that include Alternate Time Mode, Countdown Timer, ChronoGraph (stop watch/lap timer), and Daily Alarm. It is also used to revert to the Local Default Time display and access Computer Modes.

The screens of the Main Modes and Sub Modes will remain on display until a button is pressed to access another screen or Mode, activate a sequence, or for 2 minutes if no button is pressed. The ChronoGraph remains on display as long as it is running unless another Mode is accessed.

When Wet Activation is set On, the Grande will enter selected Dive Mode upon descent to 5 FT (feet)/1.5 M (meters) for 5 seconds, regardless of what operating Mode it is in.



WARNING: When Wet Activation is set OFF, the Grande must be in Dive Surface Mode (NORM < GAUG, or FREE prior to the first dive of a new series. Commencing a dive while in Watch modes will not activate Dive Mode unless Wet Activation is set ON.

<u>Main Sequence</u> (while at home) Main Time Alternate Time Countdown Timer ChronoGraph Daily Alarm
<u>Alternate Sequence</u> (at a travel location) Alternate Time Main Time (home) Countdown Timer ChronoGraph Daily Alarm



Fig. 1 - MAIN TIME

OPERATION AS A DIVE COMPUTER

The Grande features 3 Dive Computer (DC) Operating Modes, NORM (Fig. 2A) which is used for Air and Nitrox dives, GAUG (Fig. 2B) used for dives in which Nitrogen-Oxygen calculations are not performed, and FREE (Fig. 2C) used for activities that do not use SCUBA.

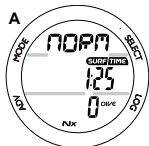

Entering Settings and Plan Mode are only available in NORM SURF Mode which also allows access to Fly, Desat, Log, and History Modes.

GAUG Mode only allows access to Fly, Log, and History Modes.



Once a dive is made in GAUG Operating Mode, the Grande is locked into that Mode for 24 hours after the dive.

PC INTERFACE

Interface with a PC is accomplished by connecting the Grande to a PC USB Port using the Bism PC Interface USB cable. The same Cable is used for Upload and Download.

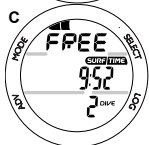

The software program is on the Bism CD, together with a USB Driver. The program's Help serves as the user manual and can be printed for personal use. The Settings Upload program is used to check the Grande's existing Settings and for entering Time, Alarm, and Dive Computer settings into the Grande.

Fig. 2 - DC MODES

The Data Download program is used to retrieve Data that was sampled during dives and stored in the Grande's memory.

The Grande checks for an External Access request once every second while in the Watch Main Time. Checks are not made if the unit is wet. For a connection to be made, the Interface Cable is clipped onto the Grande's Data Port and plugged into a PC USB Port. To establish the connection, the PC program must be running. When the connection is made, all segments of the LCD appear on the display until completion of the Upload or Download operation.

- The Grande reverts to the Watch Main Time screen after completion of the Upload or Download operation, or after 2 minutes if no PC action was taken.

SYMBOLS AND ALPHA NUMERIC GRAPHICS

The upper line of digits on the LCD screen is used to convey alpha Messages such as Day of the Week, Operating Modes, items being Set, Altitude level, and Alarm identification. At times, the second line is also used to display alpha numeric Graphics such as FO₂ and On/Off. The PO₂ values will appear in the lower line.

AUDIBLE ALARM

Most warning situations that activate the Audible Alarm while operating in NORM or GAUG Mode cause the Grande to emit 1 beep per second for 10 seconds, or until the situation is corrected, or it is acknowledged by momentarily pressing and releasing the S button (less than 2 seconds).

After being acknowledged and the situation corrected, the Alarm will sound again upon reentry into the warning situation, or entry into another warning situation.

FREE Dive Mode has its own set of Alarms which emit 3 short beeps either 1 or 3 times which cannot be acknowledged or set Off.

An LED Warning Light, located on the side of the housing, is synchronized with the Audible Alarm. It will flash as the Audible Alarm sounds. It will turn Off when the Alarm is acknowledged or the situation is corrected. The Audible and LED will not be active if the Alarm is Set OFF (a group A setting).

Situations that will activate the NORM/GAUG 10 second Alarm include -

- Descent deeper than the Max Depth Set Point selected.
- Dive Time Remaining at the Set Point selected.
- Elapsed Dive Time at the Set Point selected.
- High PO₂ at the Set Point selected.
- High O₂ of 300 OTU (single or daily exposure).
- Nitrogen Bar Graph at the segment Set Point selected.
- NORM/GAUG Ascent Rate exceeds 60 FPM (18 MPM) when deeper than 60 FT (18 M), or 30 FPM (9 MPM) at 60 FT (18 M) and shallower.
- Entry into Decompression Mode (Deco).
- Conditional Violation (above a required Deco Stop Depth for less than 5 minutes).
- Delayed Violation (above a required Deco Stop Depth for more than 5 minutes).
- Delayed Violation (a Deco Stop Depth greater than 60 FT/18 M is required).
- Delayed Violation (Max Operating Depth of 330 FT/100 M is exceeded).
- Watch Daily Alarm reaches time set (disabled during Dive Modes).
- Watch Mode Countdown Timer reaches 0:00.

A single short beep (which cannot be disabled) is emitted for the following -

- Upon completion of a Hot Swap battery change.
- Change from Delayed to Full Violation 5 minutes after the dive.

3 short beeps (which cannot be disabled) are emitted for the following -

- NORM/GAUG Ascent Rate is 51 to 60 FPM (15.1 to 18 MPM) when deeper than 60 FT (18 M), or 26 to 30 FPM (7.5 to 9 MPM) at 60 FT (18 M) and shallower.
- FREE Elapsed Dive Time Alarm (3 beeps every 30 seconds if set On).
- FREE Depth Alarms 1/2/3 (set sequentially deeper) - each 3 beeps 3 times.
- FREE NIBG Alarm (Caution zone, 4 segments) - 3 beeps 3 times.
- Entry into Deco during a FREE Dive (Permanent Violation) - 3 beeps 3 times.
- Free Dive Mode Countdown Timer reaches 0:00 - each 3 beeps 3 times.

During the following NORM Dive situations, the 10 second continuous tone will be followed by a 5 second steady beep that will not turn off when acknowledged -

- Ascending above a required Decompression Ceiling Stop Depth for more than 5 minutes (referred to as a Delayed Violation).
- Decompression requires a Ceiling Stop Depth of 70 FT (21 M) or deeper.
- Being on the Surface for 5 minutes after a Conditional Violation (Permanent Violation).

BACKLIGHT

To activate the Backlight - depress the L button for 2 seconds.

- The Backlight will then activate and illuminate the display for button depression time, then upon release the added Duration time set (0, 5, or 10 additional seconds), for a maximum illumination time of 20 seconds.
- Depress the L button again to activate as desired.



Fig. 3 - LOW BATTERY WARNING



NOTE: Extensive use of the Backlight reduces estimated Battery life. Also, the Backlight does not operate during a Low Battery Condition or when the Grande is connected to a PC.

POWER SUPPLY

The Grande utilizes one 3 volt CR2430 Lithium Battery. When used as a Dive Computer, the battery should operate normally for 1 year or 300 dive hours if 2 dives are conducted during each dive period. The Grande checks its battery voltage every 2 minutes during surface operation.

- If voltage decreases to the Warning level (2.75 volts), the Battery icon will appear on Surface display screens (Fig. 3a) as an indication that the Battery should be changed prior to commencing a series of dives.
- If voltage decreases to the Alarm level (2.50 volts), the Battery icon will flash and the message CHNG > BATT will scroll at the top of the display (Fig. 4). Operation will automatically revert to Main Time Mode. The Grande would then only operate in Watch modes until the Battery becomes completely depleted.
- Low Battery Warning/Alarm conditions are not displayed during Dive Modes.
- If a Low Battery condition was not displayed prior to starting a dive, and a Low Battery condition occurs during the dive, there will be sufficient Battery power to maintain operation for the remainder of that dive.

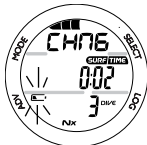

Fig. 4 - LOW BATTERY ALARM

WATCH FEATURES AND DISPLAYS



Fig. 5 - MAIN TIME

LOCAL DEFAULT TIME

Watch Main Time (Fig. 5) is the current Time at your home location and is normally selected as the Local Default Time.

The normal Watch screen sequence accessed with momentary presses (less than 2 seconds each) of the M button is -

Main Time >>> Alternate Time > Countdown Timer >
ChronoGraph > Daily Alarm.

Time for the remote location will display Am (or Pm). Local default Time will not.

Watch Alternate Time (Fig. 6), which is set by Hour Differential, is the current Time at a remote travel location. Upon arrival at the location, Alternate Time can be interchanged with Main Time to make it the Local Default Time while visiting the travel location.

The M button will then access the screens in this sequence -

Alternate Time >>> Main Time > Countdown Timer >
ChronoGraph > Daily Alarm.



Fig. 6 - ALTERNATE TIME

While viewing Alternate Time, depressing the S button for 2 seconds will replace Main Time with Alternate Time that will then become the Local Default Time until changed.

While viewing any of the Watch Mode displays, depressing the M button for 2 seconds, or if no button is pressed for 2 minutes, operation will revert to the Watch Time screen selected to be the Local Default Watch Time (Main or Alternate).

MAIN TIME, information includes (Fig. 7):

- > Nitrogen Bar Graph, if any after NORM/FREE dives.
 - > Alarm icon, if the Daily Alarm is set On (Fig. 7a).
 - > Day of the Week Graphic MON (or TUE, WED, THU, FRI, SAT, SUN), or the Graphic WET (if the unit is wet).
 - > Battery icon, if a Low Battery condition exists.
 - > Month and Day.
 - > Time of Day (hours, minutes, seconds) (Fig. 7b).
-
- Pressing M repeatedly (< 2 seconds each time) will step through the Main Watch mode screens.
 - Depressing M (2 seconds) will access the DC (dive computer) NORM Surface Main screen.
 - Pressing S (< 2 seconds) will silence and acknowledge the Daily Alarm (if set On and it sounds).
 - Pressing L (< 2 seconds) will access the Log and History screens.
 - Depressing L (2 seconds) will activate the Backlight.
 - Depressing both A and S for 2 seconds will access the Set Time screens.
 - Depressing A for 2 seconds will access the Secondary screen (Temperature, Day).



Fig. 7 - MAIN TIME
(May 31)

SET MAIN TIME

This Mode allows the Date and Time of Day to be set which will also serve as the basis for Alternate Time values.

There are 3 Time Set screens >> Set Hour Format, Set Time of Day, and Set Date.

 NOTE: Main Time must be selected as the Local Default Time in order to set the Time and Date.

Sequence of Time/Date settings:

Hour Format > Hour > Minute > Year > Month > Day.

Day of the Week is set automatically when the Date is set.

- Depressing M (2 seconds) at any time, or if no button is pressed during a period of 2 minutes, operation will revert to the Watch Main Time screen.



Fig. 8 - SET HOUR
FORMAT

While the Main screen is being displayed, depressing A and S (2 seconds) will access Set Hour Format with the Graphic HOUR, symbol TIME, and the Hour Format Set Point flashing (Fig. 8).

- Pressing S (< 2 seconds) will toggle between 12 and 24.
- Pressing A (< 2 seconds) will save the setting and access Set Time with the Hour digits flashing.

HINT >> Pressing A repeatedly (< 2 seconds each time) will step through the Time/Date Settings, bypassing those that don't require setting.

Set Hour and Minute

The Graphic A (= Am) or P (= Pm) is displayed when Time is in 12 Hour Format.



Fig. 9 - SET HOUR



Fig. 10 - SET MINUTES

- Depressing S, while the Hour digits are flashing (Fig. 9), will scroll through the Set Points in 1 Hour increments at a rate of 4 per second from 12: A to 11: P (or 0: to 23: if set for 24 Hour Format).
- Pressing A (< 2 seconds) will save the Hour setting and flash the Minute digits (Fig. 10).
- Depressing S, while the Minute digits are flashing will scroll through the Set Points in 1 minute increments at a rate of 4 per second from :00 to :59.
- Pressing A (< 2 seconds) will save the Time (hr:min) setting and access Set Date with the Year digits flashing.

Displayed on the Set Date screen will be the Graphic YEAR, Month and Day with the Year digits flashing (Fig. 11).



Fig. 11 - SET YEAR

- Depressing and holding the S button while the Year digits are flashing will scroll through the Set Points in 1 year increments at a rate of 4 per second from 2012 to 2054 (with leap year corrections).



Fig. 12 - SET MONTH

- Pressing A (< 2 sec) will save the Year setting, display the Graphic MNTH, and flash the Month digits (Fig. 12).

The Year will not be displayed in any mode other than Set Date. The Date will reset to 1.1 2012 when the Battery is replaced.

- Depressing S, while the Month digits are flashing, will scroll through the Set Points in 1 month increments at a rate of 4 per second from 1 to 12.
- Pressing A (< 2 seconds) will save the Month setting, display the Graphic DAY, and flash Day digits (Fig. 13).
- Depressing S, while the Day digits are flashing, will scroll through the Set Points in one day (01) increments at a rate of 4 per second from 1 to 31 (or the highest Day for the Month set).
- Pressing A (< 2 seconds) will save the Date setting and revert to the Watch Main Time screen.

Day of the Week is set automatically based upon the Date that has been set.



Fig. 13 - SET DAY

ALTERNATE TIME

- Pressing M (< 2 seconds) while Watch Main Time is displayed will access the Alternate Time screen.

Information includes (Fig. 14):

- > Nitrogen Bar Graph, if any after NORM/FREE dives.
- > Alarm icon (solid), if the Daily Alarm is set On.
- > Lazy 8 symbol (Fig. 14a) identifies Time as Alternate Time.
- > Day of the Week Graphic MON (or TUE, WED, THU, FRI, SAT, SUN), or WET (if the unit is wet).
- > Battery icon, if a Low Battery condition exists.
- > Month and Day.
- > Time of Day (hr:min:sec).

- Pressing M (< 2 seconds) will access Watch CDT.
- Pressing S (< 2 seconds) will silence and acknowledge the Daily Alarm (if its set On and it sounds).
- Depressing S (2 seconds) will interchange Alternate Time with Main Time making Alternate Time the Local Default Time screen.
- Depressing L (2 seconds) will activate the Backlight.
- Depressing A and S (2 seconds) will access Set Alternate Time.
- Depressing M (2 seconds) will revert to the Main Time screen.

Main Time/Date can also be set using the PC Interface program.

Prior to shipment from the factory, any error of the Main Time is determined and corrected.

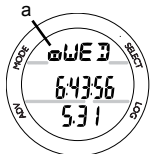

Fig. 14 - ALTERNATE TIME

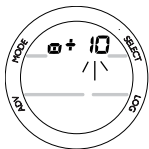

Fig. 15 - SET
ALTERNATE TIME

SET ALTERNATE TIME

- Alternate can be set OFF, or to an Hour based numeric time Differential ranging from + 1 through +23 through - 23 through -1 (hours).
- Once the Differential is selected and saved, Alternate Time/Date values will be based upon the Main Time setting plus (or minus) the Differential.

Displayed will be the Lazy 8 symbol and Graphic OFF, or the +/- numeric Hour Differential setting flashing (Fig. 15).

- Depressing S will scroll through the Set Points in increments of 1 Hour at a rate of 4 per second.
- Pressing A (< 2 seconds) will save the setting and revert to the Alternate Time screen.
- Depressing M (2 seconds), or if no button is pressed during a period of 2 minutes, operation will revert to the Main Time screen.



Fig. 16 - WATCH
COUNTDOWN TIMER

WATCH COUNTDOWN TIMER (CDT)

Pressing M 2 times (< 2 seconds each time), while the Watch Default Time screen is displayed, will access the Countdown Timer screen, displaying OFF (solid) and 0:00 if no time was previously set (Fig. 16), or the remaining Countdown Time (hr:min) if running, or OFF flashing and the previously set Countdown Time if the Countdown started and has ended.

Once set ON, a Countdown will run in the background until it counts down to 0:00, or it is set OFF, or a dive is made at which time it will default to OFF and the value previously set.

FREE Mode has separate Countdown Timer.

When a set Countdown Time reaches 0:00, the Audible Alarm will beep 10 times and the LED warning light will flash.

- Pressing S (< 2 seconds) will acknowledge/silence the Alarm.
- Pressing S (< 2 seconds) will also acknowledge/silence the Daily Alarm (if its set and it sounds).
- Pressing L (2 seconds) will activate the Backlight.
- Pressing M (< 2 seconds) will advance to ChronoGraph.
- Depressing A and S (2 seconds) will access Set Watch CDT indicated by the Graphics TIMR and SEt, symbol TIME, and Hour digits flashing (Fig. 17).
- Depressing M (2 seconds), or if no button is pressed during a period of 2 minutes, operation will revert to the Main Time screen.
- Depressing S will scroll through the Hour Set Points in 1 hour increments at a rate of 4 per second from 0: to 23:.
- Pressing A (< 2 seconds) will save the Hour setting and flash the Minutes digits.
- Depressing S will scroll through the Minutes Set Points in 1 minute increments at a rate of 4 per second from :00 to :59.



Fig. 17 - SET WATCH CDT (hr:min)



Fig. 18 - CD TIMER
STARTED

- Pressing A (< 2 seconds) will save the CDT (hr:min) Set Point and revert to the CDT screen indicated by the Graphic OFF (flashing) in place of the Graphic SET.
- Pressing S (< 2 seconds) will toggle from OFF to ON and Start the Timer (Fig. 18).
- Depressing M (2 seconds), or if no button is pressed during a period of 2 minutes, operation will revert to the Watch Default Time screen.

CHRONOGRAPH (Stop Watch/Lap Timer)

- Pressing M 3 times (< 2 seconds each), while the Watch Default Time screen is displayed, will access the ChronoGraph displaying 0:00:00.00 (hr:min:sec.1/100th sec) flashing (Fig. 19), or the elapsed time if previously started.
- Pressing S (< 2 seconds) will start the Timer which will begin counting up from 0:00:00.00 to 9:59:59.99 in increments of .01 (1/100th sec).

During the first 4 seconds, the 1/100th second values will be displayed, then 2 dashes (. - -) will be displayed. The 1/100th values will be recorded and displayed when Laps are frozen and when later recalled.



Fig. 19 - CHRONO

- Subsequent presses of S (< 2 seconds each) will freeze Lap Times (LAP1 through LAP9). After 9 Laps are recorded, additional Laps will replace Lap 9, shift the others to lower Lap numbers, while discarding Lap 1.

If the time reaches 9:59:59.99 hr:min:sec.1/100 sec, it will stop and save that number as a LAP. Subsequent presses of the S button will then have no effect.



Fig. 20 - LAP RECALL

- Pressing A (< 2 seconds) will stop the Timer and recall Lap 1, displaying the Graphic LAP1 (flashing) and the Lap 1 Time. Repeat presses of A will display other Laps/Times (Fig. 20).
- Depressing A (2 seconds) will stop the Timer and reset the Time to 0:00:00.00 (flashing).
- Depressing L (2 seconds) will activate the Backlight.
- Pressing M (< 2 seconds) will advance to Daily Alarm.
- Depressing M (2 seconds), or if no button is pressed during a period of 2 minutes, operation will revert to the Watch Default Time screen.

While the ChronoGraph is running, it will remain on the screen until a button operation is performed. If another screen is accessed, it will then continue to run in the background.

Upon descending on a dive, ChronoGraph operation will be terminated and reset to 0:00:00.00.

DAILY ALARM

When set On, the Daily Alarm will sound the Audible Alarm and flash the LED at the Time set every day.

- Pressing M 4 times (< 2 seconds each), while the Watch Default Time screen is displayed, will access the Daily Alarm screen.

DAILY ALARM STATUS, information includes (Fig. 21):

- > Alarm icon
 - > Graphics ALRM, and ON (or OFF), flashing.
 - > Alarm Time Set Point (hr:min).
-
- Pressing S (< 2 seconds) will toggle between ON and OFF.

Upon being toggled to ON, the Alarm will be set to sound every day at the Time indicated.

- Depressing A and S (2 seconds) will access Set Daily Alarm.
- Depressing L (2 seconds) will activate the Backlight.
- Pressing M (< 2 seconds), or if no button is pressed during a period of 2 minutes, operation will revert to the Watch Default Time screen.



Fig. 21 - DAILY ALARM STATUS

SET DAILY ALARM, information includes (Fig. 22):

- > Alarm icon
 - > Graphics ALRM and SET.
 - > Alarm Time previously set (hr:min) with the Hour digits flashing.
-
- Depressing S will scroll through the Hour Set Points in 1 hour increments at a rate of 4 per second from 12: Am to 11: Pm (or 0: to 23: if 24 hour format). The Graphic A (= Am) or P (= Pm) will be displayed when setting Time in 12 Hour Format.
 - Pressing A (< 2 seconds) will save the Hour setting and flash the Minutes digits.
 - Depressing S will scroll through the Minutes Set Points in 1 minute increments at a rate of 4 per second from :00 to :59.
 - Pressing A (< 2 seconds) will save the Daily Alarm (hr:min) setting and revert to the Daily Alarm screen indicated by the Graphic ON (or OFF) flashing.
 - Pressing M (< 2 seconds) will revert to the Watch Local Default Time screen.



Fig. 22 - SET DAILY ALARM

(This page intentionally left blank.)



DIVE COMPUTER FEATURES AND DISPLAYS

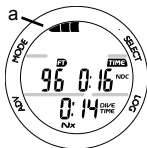

Fig. 23 - NIBG

BAR GRAPH

The Grande features one shared Bar Graph that represents either nitrogen loading, or when accessed, oxygen accumulation. By default, the Bar Graph (Fig. 23a), referred to as the Nitrogen Bar Graph (NIBG), represents your relative no decompression or decompression status.

As your Depth and Elapsed Dive Time increase, segments will add to the NIBG, and as you ascend to shallower depths, the segments of the NIBG will begin to recede, indicating that additional no decompression time is allowed.

The Nitrogen Bar Graph monitors 12 different nitrogen compartments simultaneously and displays the one that is in control of your dive. It consists of 5 segments, the left 4 represent No Decompression status and the fifth at the right indicates a Decompression condition.

When the Grande is set to operate in NORM Nitrox mode, the Bar Graph will represent oxygen accumulation when the O₂ data screen (Alternate Display) is accessed temporarily. The Graphic O₂BG will appear as an indication (Fig. 24a).



Fig. 24 - O₂BG

Regardless of which parameter the Bar Graph is representing at the time, nitrogen (if NORM or FREE) and oxygen (if NORM) calculations will continue to be performed in the background.

Displays associated with oxygen and the O2 Bar Graph will be displayed if FO2 has been set at a value other than 'Air' (e.g., a numerical value) and the Alternate screen that displays oxygen related data is accessed.

When the oxygen data screen is accessed during a NORM dive, the Bar Graph will show the maximum of either per dive accumulated oxygen or 24 hour period accumulated oxygen.

As your oxygen exposure (accumulation) increases during a NORM dive, segments will add to the O2 Bar Graph, and as saturation decreases, it will begin to recede, indicating that additional exposure is allowed for that dive and 24 hour period.

The Grande will store oxygen accumulation calculations for up to 10 dives conducted during a 24 hour period. If the maximum limit for NORM dive oxygen loading has been exceeded for that day (24 hour period), all of the segments of the O2 Bar Graph will be displayed flashing (Fig. 25).

Depth/Time values will not appear in Plan Mode until the O2 Bar Graph recedes into the normal zone (4 segments) indicating that your daily oxygen dosage has decreased an amount equivalent to the amount accumulated during the latest dive completed.



Fig. 25 - O2 ALARM

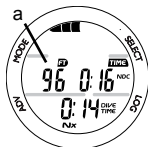

Fig. 26 - CURRENT DEPTH

While you cannot provide a guarantee against the occurrence of decompression sickness, you may choose your own personal zone of caution based upon age, physique, excessive weight, etc., to reduce the statistical risk.

Within the available NORM mode parameters that can be set (described later) are a NIBG alarm and a Conservative Factor which if set On reduces No Decompression times allowed.

ALPHA / NUMERIC DISPLAYS

Depth Displays (all Modes)

During dives, Current Depth (Fig. 26a) and Max Depth, which is accessed as an Alternate display (Fig. 27a), indicate Depths from 0 to 330 FT (100 M) in increments of 1 FT (0.1 M).

During a No Decompression Safety Stop, the set Stop Depth is displayed and during Decompression, the required Stop Depth is displayed.

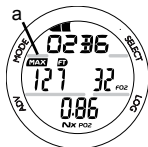

Fig. 27 - MAX DEPTH

Time and Date Displays

Time of Day and NORM/GAUG mode displays are shown in hour:minute format (i.e., 1:16 represents 1 hour and 16 minutes, not 116 minutes!).

FREE Dive Mode times are shown in minute:second format.

The colon that separates hours and minutes (or minutes and seconds) blinks once per second when the display is indicating real time (e.g., Surface Interval, Elapsed Dive Time), and is solid (non blinking) when times are calculated projections (e.g., Time to Fly, Plan).

The Primary Time display is located in the middle row of the display (Fig. 28a). Another time display (Fig. 28b) is located in the lower row. Both displays are identified by the symbol TIME.

When the Grande is operating in Dive Computer mode, Date is displayed only to identify dives when they are accessed in the Log mode.

Month appears to the left of Day (Fig. 29a) separated by a decimal point (month.day).

Temperature Display

Ambient Temperature can be viewed on the surface and during dives by accessing a Secondary Display (Fig. 30a).

The Average Temperature of each NORM/GAUG dive is recorded in the Log for that dive.



Fig. 28 - TIMES



Fig. 29 - DATE

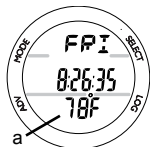

Fig. 30 - TEMPERATURE



NOTE:

Each display represents unique pieces of information.

It is imperative that you understand the formats, ranges, and values of the information represented to avoid any possible misunderstanding that could result in error.

You must also understand the icons, symbols, and alpha/numeric messages presented.

The informational displays are described in detail as the various operating modes they appear in are presented throughout this manual.

DIVE COMPUTER
SURFACE SEQUENCE
AND
OPERATING MODES

DIVE COMPUTER (DC) OPERATING MODES

The Grande features 3 selectable DC Operating Modes -

- NORM >> for normal Air or Nitrox scuba dives.
- GAUG >> for scuba dives with no nitrogen/oxygen calculations. *Once a dive is made in GAUG Mode, dive computer operation is locked into GAUG Mode for 24 hours after the dive.*
- FREE >> for breath hold dives with no scuba.

SURFACE MODE

Depressing M (2 seconds), while the Watch Default Time is displayed (Main or Alternate, whichever was selected as the default) accesses the previously selected Dive Mode Surface Main screen (NORM, GAUG, or FREE).

If no dive has been conducted within the past 24 hours, the NORM SURF MAIN will appear as the default display indicated by the graphic NORM (Fig. 31).

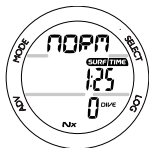

Fig. 31 - NORM SURF
MAIN
(no dive made)

- The GAUG or FREE SURF MAIN screens can be accessed by subsequent 2 second presses of M. Upon access, their graphics will flash indicating that they can be selected as the operating dive mode.
- To select a mode for diving, press M (< 2 seconds) while that graphic is flashing. When the graphic becomes solid, that mode is then selected for the type of dives to be conducted.

- The operating mode selected (NORM, GAUG, or FREE) will remain on display for 2 hours until a dive is made or Watch Mode is selected.

If a dive has been conducted within the past 24 hours, the SURF MAIN screen for that operating mode (NORM, GAUG, or FREE) will be displayed.

At any time while operating in Surface Modes, the Grande will enter Dive Mode upon descent to 5 FT (1.5 M) for 5 seconds.

- During the 2 hour pre dive surface period, if M is pressed to access other screens in the Watch Mode sequence, Surface Mode must again be accessed prior to the first dive of a series (if Wet Activation is set Off).
- When Wet Activation is set On, the wet contacts will activate the selected dive mode regardless of what mode the Grande is operating in at the time of the descent.

The Grande will enter Post Dive Surface Mode following a dive upon ascent to 2 FT (0.6 M) for 1 second. The SURF icon will flash during the first 10 minutes after a NORM/GAUG dive (Fig. 32), or 1 minute after a FREE dive.

During the first 10 minutes after a dive, the SURF MAIN screen for the operating mode selected prior to the dive (NORM, GAUG, or FREE) remains on display.

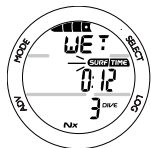

Fig. 32 - NORM
SURFACE MAIN
(Post Dive Wet)



Fig. 33 - NORM SURF MAIN

When the 10 minute surface time has elapsed, Watch Default Time (Main or Alternate) will be displayed. The SURF MAIN screen can then be accessed by depressing M (2 seconds).

NORM SURF MAIN, information includes (Fig. 33):

- > Nitrogen Bar Graph (NIBG), if any after a NORM or FREE dive.
- > Graphic NORM alternating with the Altitude Level graphic SEA (or EL2 through EL13) and WET (if the unit is wet), each On 3 seconds then 1/4 second blank.
- > Surface Interval Time (hr:min) with SURF and TIME icons.
- > Battery icon if a Low Battery Warning condition exists, flashing if Too Low.
- > Number of that dive (0 if no dive has been made yet) with DIVE icon.
- > Nx icon, if FO2 is set for a Nitrox value.

NORM SURF MAIN - Button Operations:

- Depressing M (2 seconds) will access GAUG SURF MAIN.
- Pressing M (< 2 seconds) will access Watch Default Time.
- Depressing A (2 seconds) will access NORM SURF ALT, then pressing A (< 2 seconds) will access the Secondary.
- Pressing A (< 2 seconds, repeatedly) will access Plan, then Fly, then Desat.
- Depressing A and S (2 seconds) will access Set Modes.
- Depressing L (2 seconds) will activate the Backlight.
- Pressing L (< 2 seconds) will access Log and History.

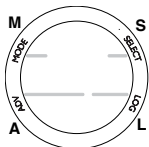

BUTTONS

NORM SURF ALTERNATE, information includes (Fig. 34):

- > Bar Graph with graphic O2BG, representing Oxygen accumulation at the end of the dive just completed.
- > FO2 Set Point with FO2 icon.
- > Nx icon.

This display is bypassed if FO2 was set for Air.



Fig. 34 - NORM SURF ALTERNATE

- Pressing A (< 2 seconds) will access the Secondary screen.
- The display will revert to the NORM SURF MAIN after 5 seconds if A is not pressed.
- Depressing L (2 seconds) will activate the Backlight.

NORM SURF SECONDARY, information includes (Fig. 35):

- > Day of the Week graphic (SAT, SUN, MON, TUE, WED, THU, FRI).
 - > Time of Day (hr:min:sec).
 - > Temperature with degree icon and graphic F (or C)
- Pressing A (< 2 seconds) will revert to the NORM SURF MAIN.
 - The display will revert to the NORM SURF MAIN after 5 seconds if A is not pressed.
 - Depressing L (2 seconds) will activate the Backlight.

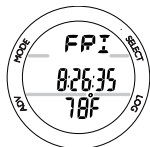

Fig. 35 - NORM SURF SECONDARY

NORM AND GAUG SET MODES

Group Sequence:

SURF MAIN >> Set F > Set A > Set U > Serial Number.

Access and step through of the sequence is gained by depressing A and S repeatedly (2 seconds each time).

Alarms (Set A) and Utilities (Set U) can also be changed using the PC Interface program.

FO2 (Set F) entries can only be made using the push buttons.

SET F GROUP (FO2)

Set F Sequence:

SET F >> Set FO2 > Set FO2 50% Default.

- > Depressing A and S (2 seconds), while the SURF MAIN is displayed, will access Set F (Fig. 36).
- > Pressing A (< 2 seconds) will then access Set FO2.



Fig. 36 - SET F

Setting FO2:

For each value of FO2, the Maximum Operating Depth (MOD) that can be achieved for the PO2 Alarm set will be displayed.

When the FO2 Default is set On and FO2 is set for a numerical value, 10 minutes on the surface after that dive, FO2 will be displayed as 50 and further dives will be calculated based on 50% O2 for oxygen calculations and 21% O2 for nitrogen calculations (79% Nitrogen) unless FO2 is set before the dive.

FO2 continues to reset to the FO2 50% Default after subsequent repetitive dives until 24 hours elapse after the last dive, or the FO2 50% Default is set Off.

When the FO2 50% Default is set Off, FO2 will remain set at the last value selected for that series of repetitive dives.

The default FO2 setting for each new dive Period (no dive made in 24 hours) is Air.

When FO2 is set for Air, the calculations are the same as when it is set to an FO2 of 21%. When FO2 is set to Air, it remains set for Air until it is set for a numerical FO2 value (21 to 50%).

When FO2 is set for Air, the O2 Bar Graph is not displayed at any time during a dive or on the surface. PO2 values and/or warnings will not be displayed during the dive.

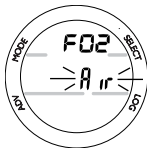

Fig. 37 - SET FO2
(Air setting)

FREE Dive nitrogen calculations are based on Air and not affected by these FO2 Settings.

Maximum Operating Depths affected by the PO2 limit set will not be displayed when FO2 is set for Air.

Internally, the Grande keeps track of the oxygen loading so that if FO2 is subsequently set for a numerical value, the oxygen accumulation for previous Air dives will be accounted for in the next Nitrox dive (during that dive period and series of repetitive dives).

Once FO2 is set for a numerical value (21 to 50%) and a dive is made, the Air option is disabled until 24 hours elapse after the last dive. The Air option will not be displayed in Set FO2 selections until a full 24 hour Surface Interval has elapsed.

If FO2 is set for 21%, it will remain set for 21% for that series of dives until set for a higher numerical value.



Fig. 38 - SET FO2
(Nitrox setting)

SET FO2, information includes (Fig. 37, 38):

- > Graphic FO2.
- > Max Depth allowed for the PO2 alarm set, blank if Air.
- > Graphic Air, or Nitrox value with FO2 icon, flashing.
- > PO2 Alarm set with PO2 icon, blank if Air.
- > Nx icon, blank if Air.

- Depressing S will scroll through FO2 values from Air to 21 through 50% in 1% increments, at a rate of 8 per second.
 - > *The scroll will stop when S is released, or momentarily at 32% (even if the button is held depressed).*
 - > *Depressing S again will resume the scroll from 32 through 50%, then stop at Air (or 21%).*
- Pressing S repeatedly (< 2 seconds) will step upward through FO2 settings one at a time.
- Pressing A (< 2 seconds) will save the setting and access Set FO2 Default.
- Depressing A and S (2 seconds) will save the setting and revert to the Set F screen.
- Depressing M (2 seconds), or if no button is pressed for a period of 2 minutes, operation will revert to SURF MAIN.

SET FO2 50% DEFAULT, information includes (Fig. 39):

- > Graphics DFLT and 50 with FO2 icon.
- > Graphic OFF (or ON) flashing.
- > Nx icon.

- Pressing S (< 2 seconds) will toggle between OFF and ON.
- Pressing A (< 2 seconds) will save the setting and revert to the Set F screen.
- Depressing M (2 seconds) or if no button is pressed for a period of 2 minutes, operation will revert to SURF MAIN.



Fig. 39 - SET FO2 50% DEFAULT



Fig. 40 - SET A

SET A GROUP (ALARMS)

Group Sequence:

SET A >> Audible > Depth > EDT > NIBG > DTR > PO2.

- > The Set A group items can also be set/changed using the PC Interface program.
- > Settings remain at the values set until changed.
- > Depressing A and S (4 seconds), while the SURF MAIN is displayed, will access Set A (Fig. 40).
- > Pressing A (< 2 seconds), while Set A is displayed, will access Set Audible Alarm.

SET AUDIBLE ALARM

This option allows the Audible Alarms and the associated warning LED function to be disabled. *Some cautionary situations will cause the Audible alarm to sound and the LED to flash even if this feature is set to OFF.*

SET AUDIBLE ALARM, information includes (Fig. 41):

- > Graphic AUD,
- > Set Point Graphic ON (or OFF) flashing.
- Pressing S (< 2 seconds) will toggle between ON and OFF.
- Pressing A (< 2 seconds) will save the setting and access Set Depth Alarm.



Fig. 41 - SET AUDIBLE

- Depressing A and S (2 seconds) will save the setting and revert to the Set A screen.
- Depressing M (2 seconds), or if no button is pressed for a period of 2 minutes, operation will revert to SURF MAIN.



Fig. 42 - SET DEPTH ALARM

SET DEPTH ALARM, information includes (Fig. 42):

- > Graphic DPTH.
- > Depth value flashing, with MAX and FT (or M) icons.
- Pressing S repeatedly (< 2 seconds) will step through the settings from 30 to 330 FT (10 to 100 M) in 10 FT (1 M) increments one at a time.
- Depressing S will scroll through the settings at a rate of 4 per second until it is released.
- Pressing A (< 2 seconds) will save the setting and access Set EDT Alarm.
- Pressing A and S (2 seconds) will save the setting and revert to the Set A screen.
- Depressing M (2 seconds), or if no button is pressed for a period of 2 minutes, operation will revert to SURF MAIN.

FREE Mode has separate Depth and EDT Alarms.

SET EDT ALARM, information includes (Fig. 43):

- > Graphic EDT (Elapsed Dive Time).
- > Time value (hr:min) flashing, with DIVE and TIME icons.
- Pressing S repeatedly (< 2 seconds) will step through the settings from 0:10 to 3:00 (hr:min) in 5 minute (:05) increments one at a time.



Fig. 43 - SET EDT ALARM

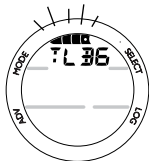

Fig. 44 - SET NIBG ALARM

FREE Mode has a separate NIBG Alarm.

Whichever Time (NDC or O2) decreases to the Alarm Set Point will activate the Alarm.



Fig. 45 - SET DTR ALARM

- Depressing S will scroll through the settings at a rate of 4 per second until it is released.
- Pressing A (< 2 seconds) will save the setting and access Set NIBG Alarm.
- Depressing A and S (2 seconds) will save the setting and revert to the Set A screen.
- Depressing M (2 seconds), or if no button is pressed for a period of 2 minutes, operation will revert to SURF MAIN.

SET NIBG ALARM, information includes (Fig. 44):

- > Graphic NIBG (Nitrogen Bar Graph).
- > Bar Graph segments flashing.

- Pressing S repeatedly (< 2 seconds) will step through the settings displaying 1, 2, 3, 4, or 5 segments.
- Pressing A (< 2 seconds) will save the setting and access Set DTR Alarm.
- Depressing A and S (2 seconds) will save the setting and revert to the Set A screen.
- Depressing M (2 seconds), or if no button is pressed for a period of 2 minutes, operation will revert to SURF MAIN.

SET DTR ALARM, information includes (Fig. 45):

- > Graphic DTR (Dive Time Remaining).
- > Time value (hr:min) flashing, with TIME, O2, and NDC icons.

- Pressing S repeatedly (< 2 seconds) will increase the setting from 0:00 to 0:20 (:minutes) in 1 minute (0:01) increments.
- Depressing S will scroll through the setting at a rate of 4 per second.
- Pressing A (< 2 seconds) will save the setting and access Set PO2 Alarm.
- Depressing A and S (2 seconds) will save the setting and revert to the Set A screen.
- Depressing M (2 seconds), or if no button is pressed for a period of 2 minutes, operation will revert to SURF MAIN.

SET PO2 ALARM, information includes (Fig. 46):

- > Graphics PO2 and AtA with MAX icon.
- > PO2 value (x.xx ATA) flashing, with PO2 icon.

- Pressing S repeatedly (< 2 seconds) will increase the setting from 1.20 (ATA) to 1.60 (ATA) in .10 (ATA) increments.
- Pressing A (< 2 seconds) will save the setting and revert to the Set A screen.
- Depressing M (2 seconds), or if no button is pressed for a period of 2 minutes, operation will revert to SURF MAIN.

Setting the PO2 Alarm to activate before reaching the Max allowed limit of 1.60 ATA is highly recommended.



Fig. 46 - SET PO2 ALARM



Fig. 47 - SET U

SET U GROUP (UTILITIES)

Group Sequence:

SET U >> Wet Activation > Units > Deep Stop > Safety Stop > Conservative Factor > Backlight Duration > Sampling Rate.

- > The Set U group items can also be set/changed using the PC Interface program.
- > Settings remain at the values set until changed.
- > Depressing A and S (6 seconds), while the SURF MAIN is displayed, will access Set U (Fig. 47).
- > Pressing A (< 2 seconds), while Set U is displayed, will access Set Wet Activation.

The settings for Wet Activation, Units, Conservative Factor, and Backlight Duration also apply to FREE Mode.

To change these settings while operating in FREE Mode, first access the NORM Surface Mode.

FREE Mode Sampling Rate is fixed at a 1 second interval and is not affected by the Set U setting.



Fig. 47 - SET WET
ACTIVATION

SET WET ACTIVATION, information includes (Fig. 48):

- > Graphic WET.
 - > ON (or OFF) flashing.
-
- Pressing S (< 2 seconds) will toggle between ON and OFF.

- Pressing A (< 2 seconds) will save the setting and access Set Units.
- Depressing A and S (2 seconds) will save the setting and revert to the Set U screen.
- Depressing M (2 seconds), or if no button is pressed for a period of 2 minutes, operation will revert to SURF MAIN.



Fig. 48 - SET UNITS

SET UNITS, information includes (Fig. 48):

- > Graphic UNIT.
- > FT icon and graphic F (or M icon and graphic C) flashing, with degrees icon.
- Pressing S (< 2 seconds) will toggle between Imperial (FT, F) and Metric (M, C).
- Pressing A (< 2 seconds) will save the setting and access Set Deep Stop.
- Depressing A and S (2 seconds) will save the setting and revert to the Set U screen.
- Depressing M (2 seconds), or if no button is pressed for a period of 2 minutes, operation will revert to SURF MAIN.

SET DEEP STOP, information includes (Fig. 49):

- > Graphic DEEP with STOP icon.
- > ON (or OFF) flashing.
- Pressing S (< 2 seconds) will toggle between ON and OFF.
- Pressing A (< 2 seconds) will save the setting and access Set Safety Stop.

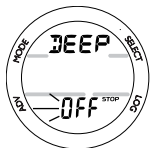

Fig. 49 - SET DEEP STOP

- Depressing A and S (2 seconds) will save the setting and revert to the Set U screen.
- Depressing M (2 seconds), or if no button is pressed for a period of 2 minutes, operation will revert to SURF MAIN.

SET SAFETY STOP information includes (Fig. 50):

- > Graphic SAFE.
 - > Stop Depth with FT (or M) icon.
 - > Stop Time (min:sec) flashing, with STOP and TIME icons.
- Pressing S (< 2 seconds each time) will step through the Stop Time settings of OFF, 3:00, and 5:00 (min:sec).
 - Pressing A (< 2 seconds) will save the Stop Time setting and flash the Depth digits, or if OFF is selected access Set Conservative Factor.
 - Pressing S (< 2 seconds each time) will step through the Stop Depth settings of 10, 15, and 20 FT (or 3, 4, 5, and 6 M).
 - Pressing A (< 2 seconds) will save the Safety Stop settings and access Set Conservative Factor.
 - Depressing A and S (2 seconds) will save the setting and revert to the Set U screen.
 - Depressing M (2 seconds), or if no button is pressed for a period of 2 minutes, operation will revert to SURF MAIN.



Fig. 50 - SET SAFETY STOP

SET CONS, information includes (Fig. 51):

- > Graphic CONS (Conservative Factor).
- > TIME and NDC icons.
- > Graphic ON (or OFF) flashing.

- Pressing S (< 2 seconds) will toggle between ON and OFF.
- Pressing A (< 2 seconds) will save the setting and access Set Backlight Duration.
- Depressing A and S (2 seconds) will save the setting and revert to the Set U screen.
- Depressing M (2 seconds), or if no button is pressed for a period of 2 minutes, operation will revert to SURF MAIN.

When the Conservative Factor is set ON, No Deco Limit times are reduced to values equivalent to those that would be available at the next higher 3000 foot (915 meter) Altitude. Refer to the tables at the back.

SET BACKLIGHT DURATION, information includes (Fig. 52):

- > Graphics GLO (meaning Backlight) and SEC.
- > Duration Time (seconds), flashing, with TIME icon.

- Pressing S (< 2 seconds each time) will step through the settings of 0, 5, and 10 (seconds).
- Pressing A (< 2 seconds) will save the setting and access Set Sampling Rate.
- Depressing A and S (2 seconds) will save the setting and revert to the Set U screen.

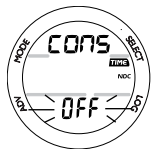

Fig. 51 - SET CONSERVATIVE FACTOR



Fig. 52 - SET BACKLIGHT DURATION

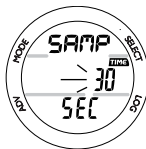

Fig. 53 - SET SAMPLING RATE

- Depressing M (2 seconds), or if no button is pressed for a period of 2 minutes, operation will revert to SURF MAIN.

SET SAMPLING RATE, information includes (Fig. 53):

- > Graphics SAMP and SEC (meaning Sampling Seconds).
- > Sampling Time (seconds), flashing, with TIME icon.

- Pressing S (< 2 seconds) will step through the settings of 2, 15, 30, 60 (seconds).
- Pressing A (< 2 seconds) will save the setting and revert to the Set U screen.
- Depressing M (2 seconds), or if no button is pressed for a period of 2 minutes, operation will revert to SURF MAIN.

SERIAL NUMBER (SN)

- Depressing A and S (8 seconds), while viewing the SURF MAIN will access the SN screen (Fig. 54):

- > Graphic SN.
- > Factory programmed Serial Number of the Grande.
- > Firmware revision number (e.g., Graphic r1A).



Fig. 54 - SERIAL NUMBER

- Depressing A and S (2 seconds) will revert to the SURF MAIN screen.
- Depressing M (2 seconds), or if no button is pressed for a period of 2 minutes, operation will revert to SURF MAIN.

NORM PLAN MODE

Bism strongly recommends that you review the PDPS (Pre Dive Planning Sequence) prior to every NORM dive to help you Plan your dive as required to avoid exceeding no decompression or oxygen exposure limits. This is especially important for repetitive dives when the PDPS indicates adjusted dive times that are available for the next dive, based on residual nitrogen or oxygen accumulation (whichever is in control) following the last dive and surface interval.

Calculated no decompression dive times in Plan Mode are based on the FO2 setting selected.

- Pressing A (< 2 seconds), while viewing the NORM SURF MAIN will access the Plan Mode Lead-in screen.
- Pressing S repeatedly (< 2 seconds each time) will step through the Planned Depths from 30 to 190 FT (9 to 57 M) in increments of 10 FT (3 M), displaying the allowable no decompression dive times (NDLs).

The PDPS will stop at the Maximum Depth that will allow theoretical no decompression dive time of at least 1 minute based upon the previous dive profiles in a series of repetitive dives and taking into account descent and ascent rates of 60 FPM (18 MPM).

When the Conservative Factor is set On, no decompression dive times are reduced to the values of the next 3000 foot (915 meter) higher Altitude.

- Pressing A (< 2 seconds) before a dive will revert to the NORM SURF Main, or after a dive access Fly Time.



Fig. 55 - PLAN LEAD-IN

PLAN MODE LEAD-IN, information includes (Fig. 55):

- > Graphic PLAN.
 - > FO2 setting with FO2 icon
 - > PO2 Alarm setting with Nx and PO2 icons, blank if Air.
- Pressing S (< 2 seconds) will access the first screen (30 FT/9 M) of the PDPS.

PDPS, information includes (Fig. 56):

- > Plan Depth value with graphic F (= feet) or M (= meters).
 - > Max Depth allowed for the PO2 Alarm value set with MAX and FT (or M) icons, blank if Air.
 - > Dive Time allowed (hr:min) with TIME and NDC (or O2 if Oxygen controlled) icons.
 - > PO2 Alarm setting with Nx and PO2 icons, blank if Air.
- Pressing S repeatedly (< 2 seconds each time) will step through the Planned Depths in increments of 10 FT (3 M), displaying the information one screen at a time.
 - Depressing M (2 seconds) will exit the PDPS and revert to the NORM SURF MAIN screen.



Fig. 56 - PDPS

FLY MODE

Time to Fly is a counter that begins counting down 10 minutes after surfacing from a dive from 23:50 to 0:00 (hr:min).

Ten minutes after surfacing from a NORM, GAUG, or FREE dive, operation reverts to the Watch Default Time screen with the Time to Fly Countdown running in the background.

Access to the FLY screen can then be gained by first accessing the NORM (or GAUG) SURF MAIN screen.

- Pressing A 2 times (< 2 seconds each time), while the NORM SURF MAIN is displayed, will access Fly Mode.
- Pressing A 1 time (< 2 seconds), while the GAUG SURF MAIN is displayed, will access Fly Mode.
- After a FREE Dive, access is gained by first accessing NORM SURF MAIN.

TIME TO FLY, information includes (Fig. 57):

- > Graphic FLY.
- > Countdown Time (hr:min) with TIME icon.
- > Battery icon if a Low Battery Warning condition exists, flashing if Too Low.
- Pressing A (< 2 seconds) will access Desat Mode after a NORM dive or revert to SURF Main after a GAUG dive.
- Depressing M (2 seconds), or if no button is pressed for a period of 2 minutes, operation will revert to SURF MAIN.



Fig. 57 - TIME TO FLY

- Depressing L (2 seconds) will activate the Backlight.

DESAT MODE

The Time to Desaturate counter provides calculated time for tissue desaturation at sea level taking into consideration the Conservation Factor setting. It begins counting down 10 minutes after surfacing from a NORM (or FREE) dive, counting down from 23:50 max to 0:00 (hr:min).

When the countdown reaches 0:00, which will generally occur prior to the Fly countdown reaching 0:00, the Desat screen remains in the sequence of accessible screens displaying 0:00 until the Fly counter shuts the Dive Computer operations Off 24 hours after a last dive.

- > The Desat screen is not displayed after a Violation Dive.
- > Desat Times greater than 24 hours will be displayed as 23: - -
- > In the event that Desat Time still remains at the end of the 24 hours countdown, the added time will be zeroed.
- > Ten minutes after surfacing from a dive, operation reverts to the Watch Default Time screen at which time the Desat countdown continues in the background. Access to the Desat screen can then be gained by first accessing the NORM SURF MAIN screen.
- Pressing A 3 times (< 2 seconds each time) while viewing the NORM SURF MAIN will access Desat Mode.

DESAT TIME, information includes (Fig. 58):

- > Graphic SAT.
 - > Countdown Time (hr:min) with TIME icon.
 - > Battery icon, if a Low Battery Warning condition exists, flashing if Too Low
-
- Pressing A (< 2 seconds) will revert to NORM SURF Main.
 - If no button is pressed during a 2 minute period, operation will revert to NORM SURF Main.
 - Depressing L (2 seconds) will activate the Backlight.

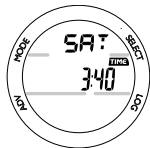

Fig. 58 - DESAT TIME

NORM/GAUG LOG MODE

Log Mode records information from the latest 24 NORM/GAUG dives and displays it sequentially in reverse order (the most recent first). Log information is retained until overwritten by another dive. Battery removal will not affect the Log data stored for viewing.

After exceeding 24 dives, the most recent Dive completed will be added to the Log and the oldest deleted.

Dives are numbered 1 to 24 starting at #1 each time a new series of dives begins. After it shuts Off 24 hours after a dive, the first dive of the next new series will be #1.

LOG & HISTORY SCREEN ACCESS

- Pressing L (< 2 seconds), at any time while on the surface, will access Log Mode displaying the first Preview screen.
- Pressing L (< 2 seconds), again, will access History Mode.

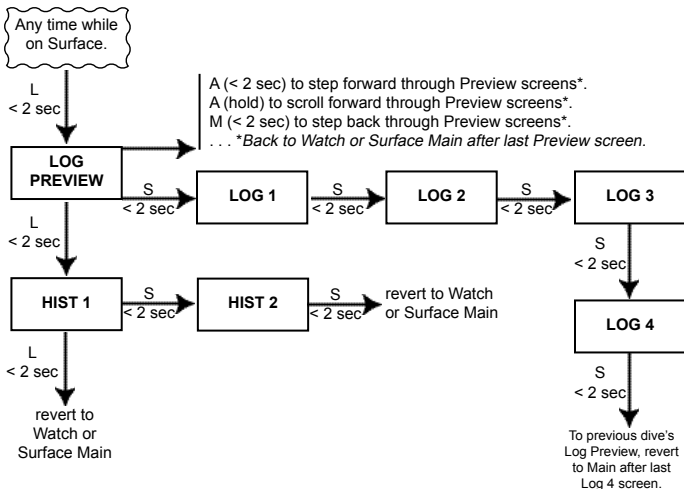

LOG PREVIEW, information includes (Fig. 59):

- > Graphic No with the dive number (1 to 24) for that series.
 - > Log icon.
 - > Pre dive surface interval time (hr:min) with SURF and TIME icons.
 - > Date the dive was started (month.day).
 - > Nx icon, if it was a NORM Nitrox dive.
-
- Pressing A repeatedly (< 2 seconds) will step through the Preview screens, most recent to oldest recorded.
 - Depressing A will scroll through the Preview screens at a rate of 4 per second.
 - Pressing M repeatedly (< 2 seconds) will step back through the Preview screens one at a time.
 - Pressing L (< 2 seconds), while viewing the first Preview screen, will advance to the History 1 screen.
 - Pressing S (< 2 seconds), while viewing a Preview screen, will display that dive's Log Data 1 screen.
 - Depressing M (2 seconds), or if no button is pressed for a period of 2 minutes, operation will revert to SURF MAIN.
 - Depressing L (2 seconds) will activate the Backlight.

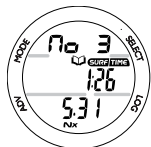

Fig. 59 - LOG
PREVIEW



Fig. 60 - LOG DATA 1

LOG DATA 1, information includes (Fig. 60):

- > Down and Up arrow icons, indicating that the times displayed represent the start and end of the dive.
- > Log and TIME icons.
- > Start time (hr:min) with graphic A (Am) or P (Pm).
- > End time (hr:min).

- Pressing S (< 2 seconds) will access Log Data 2.
- Depressing M (2 seconds), or if no button is pressed for a period of 2 minutes, operation will revert to SURF MAIN.
- Depressing L (2 seconds) will activate the Backlight.

LOG DATA 2, information includes (Fig. 61):

- > NIBG with the maximum accumulation segment flashing, others fixed up to end of dive accumulation. All segments flashing if a Violation occurred.
- > Graphic NO-D, DECO, GAUG, or VIOL indicating the type of dive when completed.
- > Log icon.
- > Maximum Depth achieved with MAX and FT (or M) icons.
- > Elapsed Dive Time (hr:min) with DIVE and TIME icons.
- > Nx icon, if a Nitrox dive.

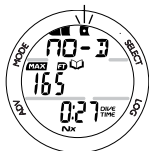

Fig. 61 - LOG DATA 2

- Pressing S (< 2 seconds) will access Log Data 3.
- Depressing M (2 seconds), or if no button is pressed for a period of 2 minutes, operation will revert to SURF MAIN.
- Depressing L (2 seconds) will activate the Backlight.

LOG DATA 3, information includes (Fig. 62):

- > Graphic AVE (average).
- > Log icon.
- > Average Depth of the dive with FT (or M) icon.
- > Average Temperature of the dive with degrees icon and Graphic F (or C).

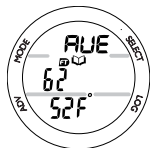

Fig. 62 - LOG DATA 3

- Pressing S (< 2 seconds) will access Log Data 4.
- Depressing M (2 seconds), or if no button is pressed for a period of 2 minutes, operation will revert to SURF MAIN.
- Depressing L (2 seconds) will activate the Backlight.

LOG DATA 4, information includes (Fig. 63):

This screen will only be displayed for NORM Nitrox dives, and bypassed for AIR, GAUG, and Violation dives.

- > O2BG, segments representing oxygen accumulated at the end of the dive with graphic O2.
- > Log icon.
- > FO2 (%) set for that dive with FO2 icon.
- > Max PO2 achieved (x.xx ATA) with PO2 icon.
- > Nx icon.

- Pressing S (< 2 seconds) will access to the previous dive's Log Preview screen, or revert to the Main after the last one.
- Depressing M (2 seconds), or if no button is pressed for a period of 2 minutes, operation will revert to SURF MAIN.
- Depressing L (2 seconds) will activate the Backlight.

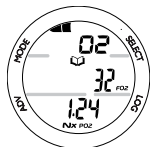

Fig. 63 - LOG DATA 4



Fig. 64 - HISTORY 1

NORM/GAUG HISTORY MODE

HISTORY Mode displays accumulative information for up to 9999 Dives, 9999 Dive Hours, and the Maximum Depth achieved. HISTORY information is retained indefinitely. Battery removal will not affect the HISTORY data stored for viewing.

- Refer to page 60 for access.

HISTORY 1, information includes (Fig. 64):

- > Graphic HIST.
- > Total Hours of Elapsed Dive Time (up to 9999) with TIME icon and graphic Hr.
- > Total number of dives recorded (up to 9999) with DIVE icon. Includes No Deco, Deco, GAUG, and VIOL dives.

- Pressing S (< 2 seconds) will access History 2.
- Depressing M (2 seconds), or if no button is pressed for a period of 2 minutes, operation will revert to SURF MAIN.
- Depressing L (2 seconds) will activate the Backlight.

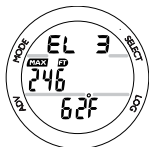

Fig. 65 - HISTORY 2

HISTORY 2, information includes (Fig. 65):

- > Graphic SEA (or EL 2 through EL 13), representing the maximum Altitude at which a dive was conducted.
- > Maximum Depth achieved during all dives with MAX and FT (or M) icons.
- > Temperature (lowest recorded of all dives) with degrees icon and graphic F (or C).

- Pressing S (< 2 seconds), or if no button is pressed for a period of 2 minutes, operation will revert to SURF MAIN.
- Depressing L (2 seconds) will activate the Backlight.

DISPLAYED SYMBOLS AND ICONS

SYMBOLS

MEANING

MAX	Maximum Depth (or PO2)
FT (or M)	Depth Units (Feet or Meters)
SURF TIME	Surface Interval Time, NORM/GAUG (hr:min) or FREE (hr:min:sec)
TIME O2	O2 Dive Time Remaining (hr:min)
TIME NDC	No Decompression Dive Time Remaining (hr:min)
TIME TAT	Total Ascent Time Deco Stops plus vertical ascent Times (hr:min)
FO2	FO2 Set Point
STOP TIME	Deco Stop Time (hr:min) or safety Stop Time (min:sec)
DIVE TIME	Elapsed Dive Time, NORM/GAUG (hr:min) or FREE (min:sec)
Nx	FO2 is set at a numerical value (21 to 50%)

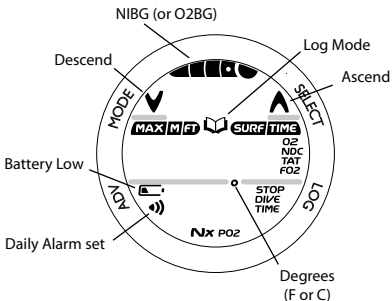

OVERVIEW OF DIVE MODE INFORMATION

DIVE TIME REMAINING (DTR)

One of the most important pieces of information on Bism dive computers is the Dive Time Remaining numeric display.

The Grande constantly monitors decompression status and oxygen accumulation.

The Dive Time Remaining display will indicate the No Deco Time or O2 Time, whichever Time is the least amount available.

No Decompression Dive Time Remaining (NDC)

NDC is the maximum amount of time that you can stay at your present Depth before entering a Decompression situation. It is calculated based on the amount of nitrogen absorbed by hypothetical tissue compartments. The rates each of these compartments absorb and release nitrogen is mathematically modeled and compared against a maximum allowable nitrogen level. Whichever one is closest to this maximum level is the controlling compartment for that depth. Its resulting value will be displayed numerically along with the TIME and NDC icons (Fig. 66a) and graphically as the NIBG (Fig. 66b).

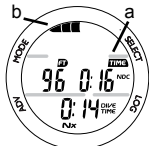

Fig. 66 - NO DECO
DIVE TIME
REMAINING

As you ascend from depth following a dive that has approached the No Decompression limit, the NIBG segments will recede as control shifts to slower compartments.

This is a feature of the decompression model that is the basis for multilevel diving, one of the most important features that Bism dive computers offer.

The algorithm used is based upon Haldane's theory using maximum allowable nitrogen levels developed by Merrill Spencer.

Repetitive diving control is based upon experiments designed and conducted by Dr. Ray Rogers and Dr. Michael Powell in 1987. Diving Science and Technology® (DSAT), a corporate affiliate of PADI®, commissioned these experiments.

Oxygen Accumulation Time Remaining (OTR)

When FO2 is set for Nitrox, oxygen accumulation (saturation or exposure) during a dive, or 24 hour period, appears graphically as the O2BG (Fig. 67a) when the Alternate (O2) screen is accessed.

As time remaining before reaching the oxygen exposure Limit decreases, segments are added to the O2BG.

When the amount of time remaining before reaching the O2 limit becomes less than NDC (No Deco Dive Time Remaining), calculations for that depth will be controlled by O2. O2 Time Remaining will then appear as Dive Time Remaining (Fig. 68a) identified by the TIME and O2 icons.

As oxygen accumulation continues to increase, segments will add to the O2BG.



Fig. 67 - O2BG



Fig. 68 - O2 DIVE TIME REMAINING

VARIABLE ASCENT RATE

Alerts associated with Ascent Rate are based upon 2 sets of speeds which change at a reference depth of 60 FT (18 M).



WARNING: At depths greater than 60 FT (18 M), Ascent Rates should not exceed 60 FPM (18 MPM). At depths of 60 FT (18 M) and shallower, rates should not exceed 30 FPM (9 MPM).

Ascent Rate Warning

At depths deeper than 60 FT (18 M), a warning (Fig. 69) will be given when Ascent Rates exceed 50 FPM (15 MPM). The message SLOW > SLOW will scroll until the Ascent is slowed. At 60 FT (18 M) and shallower, the warning will be given when Ascent Rates exceed 25 FPM (7.5 MPM).

Ascent Rate Alarm

At depths deeper than 60 FT (18 M), an alarm will sound when Ascent Rates exceed 60 FPM (20 MPM).

At 60 FT (18 M) and shallower, the alarm will sound when Ascent Rates exceed 30 FPM (10 MPM).



Fig. 69 - ASCENT WARNING/ALARM

The Audible will sound, the LED will flash, and the message SLOW > SLOW will scroll on/off at the top of the screen. The Audible and LED will stop when acknowledged with the S button or when the Ascent is slowed. After acknowledged, the message SLOW > SLOW will continue to scroll until the Ascent is slowed below the alarm rate.

ELAPSED DIVE TIME

The maximum duration that Elapsed Dive Time will be displayed is 9 hours and 59 minutes (9:59). In the event that the Grande is at depth for a greater time, it will cease operation as a Dive Computer and revert to operation as a Watch, displaying the Main Time screen.

CONTROL OF DISPLAYS

During dive modes, there is a Main (default) display of important information relevant to the specific mode that the Grande is operating in (No Deco, Deco, GAUG, FREE, etc.).

- Pressing A (< 2 seconds) will access Alternate and Secondary displays.
 - Depressing A (2 seconds) will access Deep Stop Preview (if triggered).
 - Pressing S (< 2 seconds) will acknowledge/silence Alarms.
 - Depressing L (2 seconds) will activate the Backlight.
- > *The display will be illuminated while L is depressed, then after it is released for the Backlight Duration time set (0, 5, or 10 seconds) for a maximum of 20 seconds.*
- > *The Backlight will not activate during a Low Battery condition.*

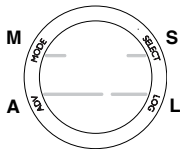



Fig. 70 - WATCH
MAIN TIME

WET ACTIVATION CONTACTS

The Dive mode Wet Activation feature is active any time Wet Activation is set On.

The Grande is configured with contacts that will automatically activate Dive mode when the space between the contacts is bridged by a conductive material (immersed in water) and it senses a depth of 5 FT (1.5 M) for 5 seconds.

The contacts are the pins of the PC Interface Data Port and the stems of the push buttons.

As long as the contacts are bridged on the surface, the graphic WET will alternate with the Day of Week graphic (MON, etc.) on the Watch Time screens (Fig. 70), and the graphics NORM and SEA (or EL2 to EL13) on the NORM, GAUG, and FREE Surface Main screens (Fig. 71).

Upon removing the bridge between the contacts (drying the Grande), the graphic WET will no longer be displayed.



Fig. 71 - NORM SURF
MAIN

The Grande will continue checking for depth, until a dive is made or it reverts to the Watch Time screen after 2 hours.

NORM TYPE DIVE MODES

NORM NO DECOMPRESSION DIVE MODE

When the Wet Activation feature is set ON, the Grande will enter the NORM No Decompression Dive Mode any time a descent is made to 5 FT (1.5 M) for 5 seconds.

When the Wet Activation feature is set OFF, the Grande will not enter Dive Mode upon descent unless it is operating in one of the NORM Dive Computer modes (menus) at that time. Modes such as Surface Mode, Plan, Fly, etc.

At any time during the dive -

- Depress L (2 seconds) to activate the Backlight.
- Press S (< 2 seconds) to acknowledge/silence Alarms.

NO DECO MAIN, information includes (Fig. 72) -

- > NIBG, loaded segments representing Nitrogen loading.
- > Current Depth with FT (or M) icon.
- > Dive Time Remaining (hr:min) with TIME and NDC (or O2) icons.
- > Elapsed Dive Time (hr:min) with DIVE and TIME icons.
- > Nx icon, if FO2 is set for Nitrox.



Fig. 72 - NORM NO DECO MAIN

- Press A (< 2 sec) to view the Alternate (ALT) display.
- Depress A (2 seconds) to view the Deep Stop Preview.

NO DECO ALT, information includes (Fig. 73) -

- > Bar Graph representing O2 accumulated with graphic O2BG, if set for Nitrox.
- > Max Depth with MAX and FT (or M) icons.
- > FO2 setting with FO2 icon, if set for Nitrox.
- > PO2 with PO2 icon, if set for Nitrox.
- > Nx icon, if set for Nitrox.

- Press A (< 2 seconds) to view the Secondary display.
- The display will revert to the Main after 5 seconds if A is not pressed.

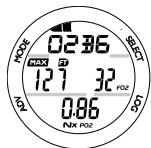

Fig. 73 - NORM NO DECO ALT

SECONDARY, information includes (Fig. 74) -

The Secondary display shown here is common to all modes during dives. Its description will not be repeated, although access to it will be described.

- > Day of the Week Graphic (MON, TUE, etc.)
 - > Time of Day (hr:min:sec). This is the Watch Default Time selected (Main or Alternate).
 - > Temperature with degrees icon and graphic F (or C)
- The display will revert to the Main after 60 seconds* or if A is pressed (< 2 seconds).

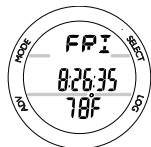

Fig. 74 - SECONDARY

**During other conditions, such as when at a Stop, the Secondary will revert to the Main after 5 seconds.*

NO DECO DEEP STOP

When the Deep Stop selection is set On, it will trigger during NORM No Deco dives when you descend to 80 FT (24 M), then calculate (and continually update) a Stop Depth equal to 1/2 the Max Depth.

While 10 FT (3 M) deeper than the calculated Stop depth, you will be able to access a Preview screen that will display the graphics DEEP >> STOP >> xxF (xxM) scrolling with the Current Depth and Stop Time (Fig. 75).

Upon initial ascent to within 10 FT (3 M) below the calculated Stop Depth, a Stop screen displaying a Stop Depth at 1/2 the Max Depth will appear with a Countdown Timer beginning at 2:00 (min:sec) and counting down to 0:00.

- > If you descend 10 FT (3 M) below, or ascend 10 FT (3 M) above, the calculated Stop Depth for 10 seconds during the countdown, the No Deco Main will replace the Deep Stop Main and the Deep Stop feature will be disabled for the remainder of that dive. There is no Penalty if the Deep Stop is ignored.
- > In the event that you enter Deco, exceed 190 FT (57 M), or a High O2 condition (\Rightarrow 80%) occurs, the Deep Stop will be disabled for the remainder of that dive.
- > The Deep Stop is disabled during a High PO2 Alarm condition (\Rightarrow Alarm setting).



Fig. 75 - DEEP STOP PREVIEW

DEEP STOP MAIN, information includes (Fig. 76)

- > NIBG.
 - > Graphics DEEP, STOP, and xxF (or xxM), scrolling.
 - > Current Depth with FT (or M) icon.
 - > Dive Time Remaining (hr:min) with TIME and NDC (or O2) icons.
 - > Stop Countdown Time remaining (min:sec) with STOP and TIME icons.
 - > Nx icon, if FO2 is set for Nitrox.
-
- Press A (< 2 seconds) to view the ALT 1 display.



Fig. 76 - DEEP STOP MAIN

DEEP STOP ALT 1, information includes (Fig. 77)

- > NIBG.
 - > Graphics DEEP, STOP, and xxF (or xxM), scrolling.
 - > Current Depth with FT (or M) icon.
 - > Dive Time Remaining (hr:min) with TIME and NDC (or O2) icons.
 - > Elapsed Dive Time (hr:min) with DIVE and TIME icons.
 - > Nx icon, if FO2 is set for Nitrox.
-
- Press A (< 2 seconds) to view the ALT 2 display, then the Secondary.
 - The display will revert to the Main after 5 seconds if A is not pressed.



Fig. 77 - DEEP STOP ALT 1

The ALT 2 and Secondary displays are similar to the NORM Dive ALT and Secondary displays.

NO DECO SAFETY STOP

Upon ascending to 5 FT (1.5 M) below the Safety Stop Depth set on any No Decompression dive in which depth exceeded 30 FT (9 M), a short beep will be emitted and a Safety Stop at the depth set will appear on the display with a countdown timer that begins at the Safety Stop Time set.

The Safety Stop will be displayed until the countdown times out (0:00 min:sec), or you descend below 30 FT (10 M), or you breach the surface. There is no Penalty if you surface prior to completing the Safety Stop.

If the Safety Stop was set to OFF, the screen will not appear during the ascent.

SAFETY STOP MAIN, information includes (Fig. 78)

- > NIBG representing Nitrogen loading.
- > Graphics SAFE, STOP, and xxF (or xxM), scrolling, indicating the Stop Depth set.
- > Current Depth with FT (or M) icon.
- > Dive Time Remaining (hr:min) with TIME and NDC (or O2) icons.
- > Safety Stop Countdown Time set/remaining (min:sec) with STOP and TIME icons.
- > Nx icon, if set for Nitrox.



Fig. 78 - SAFETY STOP MAIN

- Press A (< 2 seconds) to view the ALT 1 display, then the ALT 2, and Secondary. *Similar to the Deep Stop screens.*

DECOMPRESSION

The Grande is designed to help you by providing a representation of how close you are to entering Decompression.

Decompression mode activates when the theoretical No Decompression time and depth limits are exceeded.

Upon entry into Deco, the Audible will sound, the LED warning light will flash, and the graphic message DECO >> STOP will scroll each 3/4 second On and 1/4 second Off, until acknowledged or for 10 seconds.

Once silenced, the graphics DECO >> STOP >> xxF (or xxM) will scroll each 2 seconds On 2 seconds blank.

- Pressing S (< 2 seconds) will acknowledge/silence the Audible (unless it was set Off).
- The Up Arrow icon will flash (Fig. 79) if you are greater than 10 FT (3 M) deeper than the required Stop Depth.
- Once you are within 10 FT (3 M) of, and below, the required Stop Depth, the Up Arrow will be removed.

Managing Decompression Stops

To fulfill your decompression obligation, you should make a safe controlled Ascent to a depth slightly deeper than (Fig. 80a), or equal to, the required Stop Depth indicated (Fig. 80b) and decompress for the Stop Time indicated (Fig. 80c).



Fig. 79 - DECO ENTRY



Fig. 80 - DECO STOP



Fig. 81 - DECO STOP MAIN

The amount of decompression credit time that you receive is dependent on depth, with slightly less credit given the deeper you are below the Stop Depth indicated.

You should stay slightly deeper than the required Stop Depth indicated until the next shallower Stop Depth appears. Then, you can slowly ascend to, but not shallower than that indicated Stop Depth.

DECO STOP MAIN, information includes (Fig. 81) -

- > NIBG, all 5 segments indicating Deco.
- > Graphics DECO >> STOP >> xxF (or xxM), scrolling.
- > Current Depth with FT (or M) icon.
- > Total Ascent Time* (hr:min) with TIME and TAT icons.
- > Stop Time (hr:min) required with STOP and TIME icons.
- > Nx icon, if FO2 is set for Nitrox.

- Pressing A (< 2 seconds) will access ALT 1 (Fig. 82); then ALT 2 and Secondary, *similar to the Deep and Safety Stop screens.*



Fig. 82 - DECO STOP ALT 1

*TAT (Total Ascent Time):

TAT (Fig. 81a) includes Stop Times required at all calculated Deco Stop Depths plus vertical Ascent Time calculated at 60 FPM (18 MPM) for depths deeper than 60 FT (18 M), and 30 FPM (9 MPM) for depths of 60 FT (18 M) and shallower.

VIOLATION MODES

While in Violation modes, the Alternate and Secondary displays previously described can be accessed using the A button, the Backlight can be activated using the L button, and Alarms can be acknowledged/silenced with the S button.

CONDITIONAL VIOLATION

If you ascend shallower (Fig. 83a) than a required Decompression Stop Depth (Fig. 83b), the Audible will sound, and the LED and Down Arrow icon will flash until you descend below the required Stop Depth.

The graphic DOWN >> DOWN will scroll until the Alarm is acknowledged/silenced, then the graphics DOWN >> TO >> xxF (or xxM) will scroll.

If you descend below the required Stop Depth before 5 minutes have elapsed, the operation will continue in Decompression.

No off gassing credit will be given while above a required Stop Depth, and for each minute above it 1 $\frac{1}{2}$ minutes of Penalty Time will be added to required Stop Time and TAT (Total Ascent Time).

The added Penalty (decompression) Time will have to be worked off first, before off gassing credit will be given.

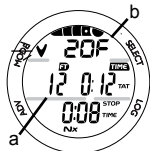

Fig. 83 - CONDITIONAL VIOLATION



Fig. 84 - DELAYED VIOLATION 1

Once the Penalty Time is worked off, and off gassing credit begins, required Deco Stop Depths and Time will decrease toward zero. The NIBG will recede into the No Deco zone and the operation will revert to the No Deco dive mode.

Upon entry into the following Violation modes, the Audible will sound and the LED will flash even if Set OFF. When these events occur, the Alarm cannot be acknowledged/silenced by pressing the S button.

DELAYED VIOLATION 1 (Fig. 84)

If you remain above the required Deco Stop Depth for more than 5 minutes, the full NIBG and Down Arrow icon will flash until you descend below the required Stop Depth. The graphics DOWN >> TO >> xxF (or xxM) will continue to scroll. This is a continuation of a Conditional Violation.



Fig. 85 - DELAYED VIOLATION 2

DELAYED VIOLATION 2 (Fig. 85)

The Grande cannot calculate Decompression times for Stop Depths much greater than 60 FT (18 M) and offers no indication of how much time spent underwater would result in the need for a greater Stop Depth.

If the Decompression obligation requires a Deco Stop Depth between 60 FT (18 M) and 70 FT (21 M), the NIBG will flash and the graphics DECO >> STOP >> 60F (18M) will scroll.

When this occurs, you must make a controlled Ascent to just deeper than, and stay as close as possible to, 60 FT (18 M) without causing the NIBG to flash.

When the required Stop Depth indicates 50 FT/15 M, etc., you can ascend to those Stop Depths and continue decompressing.

DELAYED VIOLATION 3 (Fig. 86)

If you descend deeper than the MOD (Maximum Operating Depth) of 330 FT (100 M), the Up Arrow icon will flash, and the Current Depth and Max Depth displays will only indicate 3 dashes (- - -) signifying that you are Out of Range.

The graphics TOO >> DEEP will scroll until Ascent is made above 330 FT (100 M).

Upon ascending above 330 FT (100 M), the Current Depth display will be restored, however Max Depth will only display 3 dashes for the remainder of that dive. Also, the Log for that dive will display 3 dashes as the Max Depth achieved.

VIOLATION GAUGE MODE

If a Decompression Stop Depth much greater than 60 FT (18 M) is required, an Immediate Violation Mode will be entered. This would be preceded by entering Delayed Violation 2.

The Grande would then operate in Violation Gauge Mode during the remainder of that dive and for 24 hours after surfacing.



Fig. 86 - DELAYED VIOLATION 3

Violation Gauge Mode turns the Grande into a digital instrument without any decompression or oxygen monitoring functions.

VIOLATION GAUGE MAIN, information includes (Fig. 87) -

- > Full NIBG and Up Arrow icon, flashing.
- > Graphics UP >> VIOL, scrolling.
- > Current Depth with FT (or M) icon.
- > Dive Time Remaining as 0:00 (hr:min) with TIME and NDC icons.
- > Elapsed Dive Time (hr:min) with DIVE and TIME icons.
- > Nx icon, if set for Nitrox.

Operation will also enter Violation Gauge Mode 5 minutes after surfacing from a dive in which a Delayed Violation occurred.

Violation Gauge Mode on the Surface does not allow access to the Set F, Plan, and Desat features/screens.



Fig. 87 - VIOLATION GAUGE MAIN

The countdown timer that appears when you access Time to Fly does not represent Time to Fly. It is only provided to inform you of the time remaining before normal Dive Computer operation can resume with full features and functions.

In the event that a dive is made during the 24 hour period after such a dive, a full 24 hour surface interval must then be served before all functions are restored.

VIOLATION GAUGE SURF MAIN, information includes (Fig. 88) -

- > Full NIBG, flashing
- > Graphic VIOL alternating with the graphics NORM, SEA (or EL2 - EL13), and WET (if wet).
- > Surface Interval Time (hr:min) with SURF and TIME icons.
- > Dive Number with DIVE icon.
- > Nx icon, if set for Nitrox.



Fig. 88 - VIOLATION GAUGE SURFACE

HIGH PO2

When partial pressure of oxygen (PO2) becomes equal to, or greater than, 0.20 ATA less than the PO2 Alarm value set; the Audible will sound, the LED warning light will flash, and the graphics HIGH >> PO2 will scroll until the alarm is acknowledged/silenced.

- The graphic PO2 and Up Arrow icon will appear solid on the Main (Fig. 89) as a warning until PO2 decreases.
- After the alarm is silenced, the graphics UP >> HIGH >> PO2 will scroll.

If PO2 continues to increase, the value displayed will increase toward a maximum value of 5.00 ATA in increments of 0.01.

When PO2 reaches the PO2 Alarm value set, the LED warning light will flash and the Audible will sound again.



Fig. 89 - HIGH PO2 MAIN

- > The graphic PO2 and Up Arrow icon will flash as a warning until PO2 decreases below the Alarm setting.
- > The graphics UP >> HIGH >> PO2 will continue to scroll.
- To view the PO2 value, press A (< 2 seconds) to access the ALT screen which reverts to the Main after 5 seconds.

HIGH OXYGEN ACCUMULATION

The O2BG displays either oxygen accumulated during that nitrox dive, or during the repetitive nitrox dives you conduct during that 24 hour period, whichever of the two is greater at that time. The O2BG allows you to monitor how close you are coming to the limits of oxygen exposure.

If the theoretical amount of oxygen accumulated equals, or exceeds, the limit for a single exposure, or the exposure limit for a 24 hour period (300 OTU), O2 Dive Time Remaining becomes 0:00 (hr:min), the graphic O2BG appears and the full Bar Graph and Up Arrow icon will flash (Fig. 90).

The Audible will sound, the LED will flash, and the graphics HIGH >> O2 will scroll. When the Alarm is acknowledged/silenced, the graphics UP >> HIGH >> O2 will scroll until the level of O2 decreases below the limit.

- Pressing A (< 2 seconds) will access the Alternate and Secondary screens similar to No Deco.

Upon surfacing, operation will lock in to NORM Mode until the O2BG recedes to 4 segments. Access to Watch Mode is allowed but access to GAUG and FREE is blocked.



Fig. 90 - HIGH O2 MAIN

NORM POST DIVE MODES

POST DIVE SURFACE MODE

When you ascend to 2 FT (0.6 M), operation will enter Surface Mode and begin counting your Surface Interval.

TRANSITION PERIOD

If you descend the first 10 minutes after surfacing (referred to as the Transition Period), time underwater will be considered a continuation of that dive. The time at the surface (if less than 10 minutes) will not be added as Dive Time.

Transition Period information on the surface includes (Fig. 91):

- > NIBG.
- > Graphic NORM alternating with the graphics SEA (or EL2 through EL13) and WET (if wet). If a Low Battery condition occurs during a dive, the message CHNG > BATT will scroll upon surfacing.
- > Battery icon if a Low Battery Warning condition exists, flashing if Too Low.
- > Surface Interval Time (hr:min) with SURF and TIME icons.
- > Dive Number with DIVE icon.
- > Nx icon, if set for Nitrox.

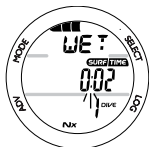

Fig. 91 - TRANSITION PERIOD

During the Transition Period, Alternate displays and the Log can be accessed. Other modes (e.g., Plan, Fly, Sat, Set) will be accessible after 10 minutes on the surface.

Log Data will not be stored in the unit's memory until the 10 minute Transition Period on the surface is completed.

AFTER THE TRANSITION PERIOD

Once 10 minutes have elapsed, the SURF icon will stop flashing indicating that the Dive and Transition Period are completed, and a subsequent descent will be considered a new dive.

Operation will then revert to Watch Default Time. NORM SURF Main (Fig. 92) can be accessed from Watch Default Time screen by pressing M (2 seconds). You will then have full access to other NORM surface modes and displays.

- Press L (< 2 seconds) to access Log and History.
- Depress L (2 seconds) to activate the Backlight.
- Press A (< 2 seconds) to access Plan, Fly, and Desat.
- Depress A (2 seconds) to access ALT and Secondary.
- Depress A & S (2 seconds) to access Set Modes.
- Press M (< 2 seconds) to access Watch Default Time.



Fig. 92 - NORM SURF
MAIN
(after Transition Period)

SUMMARY OF NORM/GAUG WARNING AND ALARM MESSAGES

<u>MESSAGE</u>	<u>MEANING</u>
DECO > STOP > xxF (M)	Entry into Decompression Mode.
DOWN > TO > xxF (M)	Above a Required Decompression Stop Depth.
DECO > STOP > 60F (18M)	Deco Stop greater than 60 FT (18 M) required.
UP > HIGH > PO2	High PO2 alarm while in No Deco Mode.
HIGH > PO2	High PO2 alarm while in Deco Mode.
UP > HIGH > O2	High O2 alarm.
TOO > DEEP	Depth alarm.
UP > VIOL	Deco Stop greater than 70 FT (21 M) required.
SLOW > SLOW	Ascent Rate Too Fast alarm.
LOW > DIVE > TIME	Dive Time Remaining alarm.
TIME > TOO > LONG	Elapsed Dive Time alarm.
UP > HIGH > NI	NIBG alarm.

GAUGE OPERATING MODE

GAUGE MODE (GAUG)

When GAUG is selected as the operating mode, the Grande will operate as a digital depth gauge/timer without performing nitrogen and oxygen calculations.

- To access GAUG mode, while the NORM SURF Main is displayed, depress M (2 seconds).
- The graphic GAUG will flash during which a press of M (< 2 seconds) will select GAUG as the operating dive mode. *GAUG will stop flashing.*
- If no GAUG dive has been conducted, depress M (2 seconds) to access FREE SURF Main.

GAUG SURF MAIN, (Fig. 93) -

- > Graphic GAUG alternating with the Altitude Level graphic SEA (or EL2 through EL13) and WET (if wet).
- > Surface Interval Time (hr:min) with SURF and TIME icons.
- > Battery icon if a Low Battery Warning condition exists, flashing if Too Low.
- > Dive Number with DIVE icon.



Fig. 93 - GAUG SURF MAIN

- Depressing M (2 seconds) will access FREE SURF MAIN.
- Pressing M (< 2 seconds) will access Watch Default Time.
- Depressing A (2 seconds) will access the Secondary.
- Pressing A (< 2 seconds) will access Fly.
- Depressing A and S (2 seconds) will access Set Modes.
- Depressing L (2 seconds) will activate the Backlight.
- Pressing L (< 2 seconds) will access Log and History.

*Upon descending to 5 FT (1.5 M) for 5 seconds,
operation will enter GAUG Dive Mode.*

Once a dive is made in GAUG mode, you must wait 24 hours after surfacing before the Grande will operate in NORM mode or FREE Dive mode.

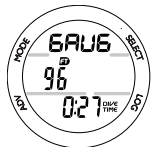

Fig. 94 - GAUG DIVE MAIN

GAUG DIVE MAIN, information includes (Fig. 94) -

- > Graphic GAUG.
- > Current Depth with FT (or M) icon.
- > Elapsed Dive Time (hr:min) with DIVE and TIME icons.

- Pressing A (< 2 seconds) will access the ALT screen.
- Depressing L (2 seconds) will activate the Backlight.

GAUG DIVE ALT, information includes (Fig. 95) -

- > Graphic GAUG.
- > Max Depth with MAX and FT (or M) icons.
- > Elapsed Dive Time (hr:min) with DIVE and TIME icons.

- Pressing A (< 2 seconds) will access the Secondary screen.
- Depressing L (2 seconds) will activate the Backlight.
- Operation will revert to the Main after 5 seconds if A is not pressed.

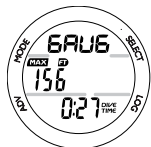

Fig. 95 - GAUG DIVE ALT

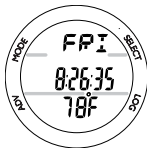

Fig. 96 - SECONDARY

SECONDARY DISPLAY, information includes (Fig. 96) -

- > Day of the Week Graphic (MON, TUE, etc.).
 - > Time of Day (hr:min). *This will be the Watch Time selected (Main or Alternate).*
 - > Temperature with degrees icon and Graphic F (or C).
-
- Operation will revert to the Main after 5 seconds or if A is pressed (< 2 seconds).
 - Depressing L (2 seconds) will activate the Backlight.

FREE DIVE OPERATING MODE

FREE DIVE MODE (FREE)

When FREE is selected as the operating mode, the Grande will operate as a digital depth gauge with select features. Nitrogen calculations are based upon a default FO2 of Air and the amount remaining during 24 hours is carried over between FREE and NORM modes.

- To access FREE mode, while the GAUG SURF Main is displayed (and no GAUG dive was made), depress M (2 seconds).
- Press M (< 2 seconds), while FREE is flashing, to select FREE mode for the type of dives to be conducted.

FREE SURF MAIN, information includes (Fig. 97) -

- > NIBG, if any after FREE or NORM dives.
- > Graphic FREE alternating with the Altitude graphic SEA (or EL 2 through EL13) and graphic WET (if wet), each 3 seconds On then 1/4 second Off.
- > Surface Interval Time (min:sec up to 59:59, then hr:min) with SURF and TIME icons.
- > Battery icon if a Low Battery Warning condition exists.
- > Total number of repetitive FREE Dives conducted in that series with DIVE icon.



Fig. 97 - FREE SURF MAIN

- Depressing M (2 seconds) will access NORM SURF MAIN.
- Pressing M (< 2 seconds) will access Watch Default Time.
- Depressing A (2 seconds) will access the ALT screen.
- Pressing A (< 2 seconds) will access FREE CDT.
- Depressing A and S (2 seconds) will access Set Alarms.
- Depressing L (2 seconds) will activate the Backlight.

FREE SURF ALT, information includes (Fig. 98) -

- > Graphic LAST, indicating that information relates to the last FREE dive conducted.
- > Maximum Depth of the dive previously made while still in FREE mode with MAX and FT (or M) icons.
- > Elapsed Dive Time (min:sec) of the dive previously made while still in FREE mode with DIVE and TIME icons. Resets to 0:00 after 24 hours.

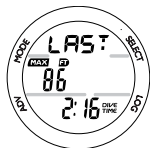

Fig. 98 - FREE SURF ALT

- Pressing A (< 2 seconds) will access the Secondary.
- Depressing L (2 seconds) will activate the Backlight.
- Operation will revert to the Main after 5 seconds if A is not pressed.

SECONDARY, information includes (Fig. 99) -

- > Day of the Week Graphic (MON, TUE, etc.)
 - > Time of Day (hr:min). This will be the Watch Default Time selected (Main or Alternate).
 - > Temperature with degrees icon and Graphic F (or C).
- Operation will revert to the Main after 5 seconds or if A is pressed (< 2 seconds).

FREE Mode uses the NORM/GAUG settings for -

- >> Time/Date
- >> Wet Activation
- >> Units
- >> Conservative Factor

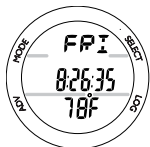

Fig. 99 - SECONDARY



Fig. 100 - CDT ON/
RUNNING

FREE CDT STATUS, information includes (Fig. 100/101) -

- > Graphic TIMR.
- > Remaining Countdown time (min:sec) with the colon flashing and the TIME icon, if ON and a CD is in progress.
- > 0:00 will be displayed, if the CD Timer is ON and no time is remaining.
- > If the CD Timer is OFF, the CD Time (min:sec) previously set will be displayed.
- > Graphic OFF (or ON), flashing.

- Pressing S (< 2 seconds) will toggle between ON and OFF.

- > *If a Time has been set, a toggle from OFF to ON will Start the CD Timer indicated by the colon flashing.*

- > *An ON/OFF toggle is prevented when S is operated to acknowledge/silence the Watch Daily Alarm.*

- Pressing A (< 2 seconds), or if no button is pressed during a period of 2 minutes, operation will revert to the Main.

- Depressing A and S (2 seconds), when the CD Timer is OFF, will access Set CDT.



Fig. 101 - CDT OFF

Once the CD TIMER has been set and started (by selecting ON), it will continue to run in the background while on the surface until turned OFF (stopped) or the Time reaches 0:00 at which time the alarm will strike (3 short beeps 3 times), the message TIMR will be displayed, and the CDT will revert to OFF.

Upon entering FREE Dive Mode, CDT operation will continue, if in progress. During a dive, the CDT can be turned Off (stopped) and On (started), but not Set.

SET CDT (Surface only), information includes (Fig. 102) -

- > Graphic TIMR, solid.
 - > Timer setting (min:sec) with the TIME icon, colon solid, Minute digits flashing.
 - > Graphic SEt, solid.
-
- Depressing S will scroll through the Minute settings at a rate of 4 per second from 0: to 59: in 1 Minute (1:) increments.
 - Pressing S repeatedly (< 2 seconds each time) will step through the settings one at a time.
 - Pressing A (< 2 seconds) will save the Minute setting and flash the Seconds digits.
 - Depressing S will scroll through the Seconds settings at a rate of 4 per second from :00 to :59 in 1 Second (:01) increments.
 - Pressing S repeatedly (< 2 seconds each time) will step through the settings one at a time.
 - Pressing A (< 2 seconds) will save the CDT (min:sec) setting indicated by the graphic OFF flashing in place of the Graphic SEt (Fig. 102).
 - Pressing S (< 2 seconds) will toggle to ON and Start the CDT.



Fig. 101 - SET FREE CDT

The Set Point for the Watch CDT does not affect the FREE CDT.



Fig. 102 - FREE CDT SET/READY

The Set Point for the NORM/ GAUG EDT Alarm does not affect the FREE EDT Alarm.

- Pressing A (< 2 seconds), or if no button is pressed during a period of 2 minutes, operation will revert to the Main.

FREE EDT (ELAPSED DIVE TIME) ALARM

The FREE EDT Alarm is factory set for 30 seconds. When set ON, the Alarm will sound 3 short beeps and the graphic TIME will be displayed momentarily every 30 seconds while operating underwater in FREE Dive Mode.

- Depressing A and S (2 seconds), while the FREE SURF Main is displayed, will access Set EDT Alarm.

The FREE EDT Alarm can only be Set (turned OFF or ON) while on the Surface and cannot be changed during a Dive.

SET EDT ALARM, information includes (Fig. 103) -

- > Graphic EDT.
- > Pre set interval :30 (:sec) with TIME icon.
- > Graphic OFF or ON, flashing.



Fig. 103 - SET FREE EDT ALARM

- Pressing S (< 2 seconds) will toggle between OFF and ON.
- Pressing A (< 2 seconds) will save the setting and access Set Depth Alarm 1.
- Depressing M (2 seconds), or if no button is pressed during a period of 2 minutes, operation will revert to the Main.

FREE DEPTH ALARMS (FDA)

The Grande features 3 FREE Depth Alarms that can be set at progressively deeper depths and turned OFF/ON.

- > If Alarm 1 is set OFF, then Alarms 2 and 3 will be disabled.
- > If Alarm 2 is set OFF, Alarm 3 will be disabled.

When each of the depths are reached during a dive, 3 short beeps will sound 3 times and the message DPTH will be displayed 3 times.

SET FDA1, information includes (Fig. 104) -

- > Graphic FDA1.
 - > Depth value, flashing when ON is displayed, with MAX and FT (or M) icons.
 - > Graphic ON or OFF, flashing.
- Pressing S (< 2 seconds) will toggle between ON and OFF.
 - Pressing A (< 2 seconds) will save the ON/OFF selection.
- > If OFF is selected, Set FDA 2 and 3 will be bypassed and operation will revert to the Main.
 - > If ON is selected, the Depth digits will flash.
- Pressing S repeatedly (< 2 seconds each time) will step through the settings one at a time from 30 to 330 FT (10 to 100 M) in increments of 10 FT (1 M).

The Set Point for the NORM/GAUG Depth Alarm does not affect the FREE Depth Alarms.



Fig. 104 - SET FREE DEPTH ALARM 1

The range of available FDA 2 settings begins at the next FT/M value greater than the FDA 1 Alarm value set.

- Depressing S will scroll through the settings at a rate of 4 per second.
- Pressing A (< 2 seconds) will save the setting and access Set FDA 2.
- Depressing M (2 seconds), or if no button is pressed during a period of 2 minutes, operation will revert the Main.

SET FDA2, information includes (Fig. 105) -

- > Graphic FDA2.
 - > Depth value, flashing when ON is displayed, with MAX and FT (or M) icons.
 - > Graphic ON or OFF, flashing.
-
- Pressing S (< 2 seconds) will toggle between ON and OFF.
 - Pressing A (< 2 seconds) will save the ON/OFF selection.
-
- > If OFF is selected, Set FDA 3 will be bypassed and operation will revert to the Main.
 - > If ON is selected, the Depth digits will flash.



Fig. 105 - SET FREE DEPTH ALARM 2

- Pressing S repeatedly (< 2 seconds each time) will step through the settings one at a time from 40 to 330 FT (11 to 100 M) in increments of 10 FT (1 M).
- Depressing S will scroll through the settings at a rate of 4 per second.
- Pressing A (< 2 seconds) will save the setting and access Set FDA 3.

- Depressing M (2 seconds), or if no button is pressed during a period of 2 minutes, operation will revert the Main.

SET FDA3, information includes (Fig. 106) -

- > Graphic FDA3.
 - > Depth value, flashing when ON is displayed, with MAX and FT (or M) icons.
 - > Graphic ON or OFF, flashing.
- Pressing S (< 2 seconds) will toggle between ON and OFF.
 - Pressing A (< 2 seconds) will save the ON/OFF selection.
- > If OFF is selected, operation will revert to the Main.
 - > If ON is selected, the Depth digits will flash.
- Pressing S repeatedly (< 2 seconds each time) will step through the settings one at a time from 50 to 330 FT (12 to 100 M) in increments of 10 FT (1 M).
 - Depressing S will scroll through the settings at a rate of 4 per second.
 - Pressing A (< 2 seconds) will save the setting and access Set FDA 2.
 - Depressing M (2 seconds), or if no button is pressed during a period of 2 minutes, operation will revert the Main.

The range of available FDA 3 Set Points begins at the next FT/M value greater than the FDA 2 Alarm Set Point.



Fig. 106 - SET FREE DEPTH ALARM 3



Fig. 107 - FREE DIVE
MAIN

FREE DIVE MAIN, information includes (Fig. 107) -

- > NIBG, if any from previous NORM or FREE Dives.
- > Graphic FREE.
- > Depth with FT (or M) icon.
- > No Deco Dive Time remaining (hr:min) with TIME and NDC icons.
- > Elapsed Dive Time (min:sec) with DIVE and TIME icons.

- Pressing A (< 2 seconds) will access FREE CDT Status.
- Depressing L (2 seconds) will activate the Backlight.



Fig. 108 - FREE CDT
STATUS (OFF/READY)

FREE CDT STATUS, information includes (Fig. 108/109) -

- > Graphic TIMR
- > Remaining Countdown time (hr:min:sec) with the TIME icon; colon flashing if ON and a CD is in progress; 0:00 with the colon flashing if ON and no time is remaining. If OFF, the CD Time previously set will be displayed with the colon solid.
- > Graphic ON (or OFF), flashing.



Fig. 109 - FREE CDT
STARTED

- Pressing S (< 2 seconds) will toggle between ON and OFF.
If a Time has been set, a toggle from OFF to ON will Start the CD TIMER indicated by the colon flashing.
- Depressing L (2 seconds) will activate the Backlight.
- Depressing M (2 seconds), or if no button is pressed during a period of 10 seconds, operation will revert to the Main.

FREE DIVE ALARMS

All FREE Dive Alarms will sound 3 short beeps (1 or 3 times) with a message displayed to indicate that an event is occurring and as a reminder to view the display to identify the event.

FREE CDT (Count Down Timer) Alert

When the FREE CDT decreases to 0:00 (min:sec), 3 short beeps will sound 3 times and the graphic TIMR will flash 3 times in place of FREE (Fig. 110).



Fig. 110 - FREE CDT ALERT

FREE DEPTH Alarms

When Depth reaches the FDA 1 value selected, 3 short beeps will sound 3 times and the graphic DPTH will flash 3 times in place of FREE (Fig. 111).



Fig. 111 - FREE DEPTH ALARM

- > The beeps and message will be repeated when Depth reaches the FDA 2 and FDA 3 values set, if set ON.
- > If Ascent is made above an FDA set value and then a descent is made to below it again, the respective Alarm (FDA) will sound again.

FREE EDT (Elapsed Dive Time) Alarm

When the EDT Alarm is set ON, 3 short beeps will sound and the graphic TIME will flash in place of FREE (Fig. 112).



Fig. 112 - FREE EDT ALARM

- > This Alarm is factory set to repeat every 30 seconds during FREE Dive Mode, when it is set ON.



Fig. 113 - FREE NIBG ALARM

FREE NIBG (Nitrogen Bar Graph) Alarm

While diving in FREE mode, nitrogen accumulation from the FREE Dives and any NORM SCUBA dives conducted within 24 hours is displayed as the NIBG.

When nitrogen loading increases to the caution level (4 NIBG segments), the Up Arrow icon appears solid, 3 short beeps will sound 3 times, and the graphics UP >> HIGH >> NI will scroll in place of FREE (Fig. 113).



Fig. 114 - FREE DIVE VIOLATION (DECO)

The message will continue to scroll until the NIBG recedes to 3 segments at which time the message will change to FREE and the UP Arrow will be removed.

Entry into DECO during a FREE Dive

In the event that nitrogen loading increases to the Deco level (5 NIBG segments), the NIBG will flash, the Up Arrow will flash, 3 short beeps will sound 3 times, and the graphics UP >> VIOL will scroll in place of FREE (Fig. 114).

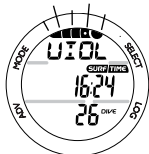

Fig. 115 - FREE SURF VIOLATION (DECO)

The message will continue to scroll until you surface, then the graphic VIOL will flash for 10 minutes after the dive.

Upon surfacing, the Up Arrow will be removed, however, the full NIBG will continue to flash for 24 hours and dive computer operation will revert to Violation Mode (Fig. 115) until a full 24 hours elapse with no diving. Access to Watch Mode will be allowed, but access to NORM or GAUG will be blocked.

REFERENCE

CARE AND CLEANING

Protect your Grande from shock, excessive temperatures, exposure to chemicals, and tampering. Protect the lens against scratches with a Instrument Lens Protector. Small scratches will naturally disappear underwater.

- Soak and rinse the Grande in fresh water at the end of each day of diving, and check to ensure that the areas around the Low Pressure (Depth) Sensor (Fig. 116a), PC Interface Data Port (Fig. 116b), and Buttons are free of debris or obstructions.
- To dissolve salt crystals, use lukewarm water or a slightly acidic bath (50% white vinegar/50% fresh water). After removal from the bath, place the Grande under gently running water and towel dry before storing.
- Transport your Grande system cool, dry, and protected.

INSPECTIONS AND SERVICE

Your Grande should be inspected annually by an Authorized Bism Dealer who will perform a factory prescribed function check and inspection for damage or wear.

Bism recommends that you continue to have an inspection performed every year to ensure it is working properly.

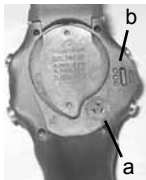

Fig. 116 - CASE BACK

To Obtain Service:

Take your Grande to an Authorized Bism Dealer.

The procedures that follow must be closely adhered to.

BATTERY REPLACEMENT

The battery compartment should only be opened in a dry and clean environment with extreme care taken to prevent the entrance of moisture or dust.

As an additional precautionary measure to prevent formation of moisture in the battery compartment, it is recommended that the battery be changed in an environment equivalent to the local outdoor temperature and humidity (e.g., do not change the battery in an air conditioned environment then take it outside during a hot sunny day).

Inspect the buttons, lens, and housing to ensure they are not cracked or damaged. If there is any sign of moisture in the Grande, DO NOT attempt to use it for diving (NORM, GAUG, or FREE) until it receives proper service by the Bism factory.

Hot Swap

If the new battery can be inserted within 8 seconds after the old one is removed (referred to as a Hot Swap), settings and nitrogen-oxygen calculations for repetitive dives will be retained.



Fig. 117 - BATTERY COVER REMOVAL (using tool)



Fig. 118 - BATTERY COVER REMOVAL (without tool)



Fig. 119 - BATTERY REMOVAL

Battery Removal

- Locate the battery compartment on the back of the unit.
- Rotate the battery cover clockwise 10 degrees using the special battery cover tool provided (Fig. 117), or by pushing the lower portion to the left while pushing the upper portion to the right (Fig. 118).
- Lift the cover with o-ring up and away from the housing.
- Using care not to damage the contact (Fig. 119a), slide the battery up and out of the left side of the battery compartment.
- Discard the battery according to local regulations governing disposal of Lithium batteries.



CAUTION: DO NOT allow a metal object to short circuit the top of the battery which is positive (+) to the negative (-) contact of the battery compartment.

Inspection

- Closely check all of the sealing surfaces for any signs of damage that might impair proper sealing.
- Inspect the buttons, lens, and housing to ensure they are not cracked or damaged.



WARNING: If damage or corrosion is found, return your Grande to an Authorized Bism Dealer, and **DO NOT** attempt to use it until it has received factory prescribed service.

- Remove the battery cover o-ring and inspect it for any signs of deterioration or deformity. **DO NOT** use tools to remove the o-ring.
- To ensure proper sealing, o-ring replacement is highly recommended each time the battery is replaced.
- Closely examine the threads of the battery cover and Housing for any signs of damage that might prevent proper threading.
- Closely examine the inside of the battery compartment for any signs of corrosion indicating entrance of moisture into the unit.
- If corrosion is found, return the Grande to an Authorized Bism Dealer, and **DO NOT** attempt to use it until it has received factory service.
- If moisture is found, it is best to have the unit inspected and cleaned by an Authorized Bism Dealer.
- If it is necessary to clean the battery compartment, flush it and all components with a solution of 50% white vinegar and 50% fresh water. Rinse with fresh water, and allow to dry overnight or blow dry with a hair dryer set at no heat.



Fig. 120 - BATTERY
INSTALLATION

Battery Installation

- Slide a new 3 volt type CR2430 Lithium Battery, negative side down into the battery cavity.

Slide it in from the left side (Fig. 120) and ensure that it slides under the contact clip on the lower/right rim of the cavity.

- Lightly lubricate the new cover o-ring with silicone grease and place it on the inner rim of the battery cover.

Ensure that it is evenly seated (Fig. 121).



NOTE: The cover o-ring must be a genuine Bism part that can be purchased from an Authorized Bism Dealer.

- Carefully place the battery cover (with o-ring) into position on the rim of the battery compartment, then press it evenly and completely down into place.



Fig. 121 - BATTERY
COVER O-RING

- Maintain the battery cover securely in place and turn it counter clockwise 10 degrees using the special battery cover tool provided (Fig. 122), or by pushing the lower portion to the right while pushing the upper portion to the left (Fig. 123).

Testing

- Observe the LCD display to ensure it is consistently clear and sharp in contrast throughout the screen.
- Set the Date, Main Time, Alternate Time, and Daily Alarm.
- Verify all settings prior to diving.
- If any portions of the display are missing or appear dim, or if a Low Battery condition is indicated, return your Grande to an Authorized Bism Dealer for a complete evaluation before attempting to use it.



Fig. 123 - BATTERY COVER O-RING (without tool)



Fig. 122 - COVER INSTALLATION (using tool)

UPLOADING SETTINGS AND DOWNLOADING DATA

The Grande is configured with a Data Port located on the back of the left side that enables it to be connected to a PC through a USB port using a special Interface Cable.

A USB Driver is provided on the program CD as part of the Interface System.

The Settings Upload portion of the PC Interface program can be used to set/change the Main Time, Date, Set A group (Alarms), and Set U group (Utilities) using the same Interface System. The Set F group (FO2) and FREE Mode Alarms must be entered using the button controls.

Information available for retrieval (DownLoad) to the PC program includes dive number, surface interval time, maximum depth, elapsed dive time, start date, start time, lowest temperature under water, sampling rate, dive profile, settings, NIBG, O2BG, and FO2.

The Grande checks for the presence of an interface device connection to the Data Port once every second while in Watch Default Time Mode. Checks are not made if the Wet Activation contacts are wet. Upon sensing an interface connection, the requesting device (PC) connects to the Grande and is prepared for Upload of settings or Download of data which is then initiated using the PC programs.

Prior to attempting to Download data from your Grande or Upload settings to it, review the HELP section of the interface program. Recommended is to print those sections of HELP that you consider appropriate for your Interface activities.

PC compatibility requirements:

- IBM, or compatible, Personal Computer with USB Port
 - Intel, Pentium 200 MHz or better microprocessor
 - Microsoft, Windows, 2000, XP, Vista, or 7
 - Super VGA card or compatible video Graphics adaptor (256 color or greater) with a minimum 800 X 600 pixel screen area of display settings
 - 64 MB of available RAM
 - 60 MB of available hard drive storage
 - Mouse, CD-ROM/DVD drive, Printer
-

ERROR (RESET DURING A DIVE)

If for any reason, the Grande shuts Off then turns On again for any reason during any Dive, the message ERR (Error) will be displayed with the Up Arrow and current Depth (Fig. 124).

If this occurs, it is highly recommended that you terminate the dive and begin a safe ascent to the surface.

Upon surfacing, and any time thereafter, when access to Dive Computer Operating Mode is attempted from Watch Mode, only the message ERR will be displayed (Fig. 125).

No Dive Computer Modes/screens will be inaccessible.

If this occurs, the Grande must be returned to the factory for evaluation/service prior to any further use for diving activities.



Fig. 124 -ERROR WHILE DIVING



Fig. 125 -SURFACE AFTER ERROR DURING A DIVE

ALTITUDE SENSING AND ADJUSTMENT

Prior to the first dive of a series of repetitive dives, Altitude (i.e., ambient pressure) is measured upon activation of Dive Surface Mode and every 15 minutes until a dive is made or operation reverts to Watch Default Time after 2 hours.

- > While it is operating in Watch Modes after a dive, measurements are taken every 15 minutes during the 24 hour period after surfacing.
- > Measurements are only taken when the unit is dry.
- > Two readings are taken, the second reading 5 seconds after the first. The readings must be within 1 foot (30 cm) of each other to record that ambient pressure as the current Altitude.

The mathematical model in the Grande accounts for the reduced No Decompression dive time available based on National Oceanic and Atmospheric Administration (NOAA) guidelines.

When diving in high altitude waters from 3,001 to 14,000 feet (916 to 4,270 meters), the Grande automatically adjusts to these conditions providing corrected depth, reduced No Decompression times, and reduced oxygen accumulation times at intervals of 1,000 feet (305 meters).

No adjustments are made during any time that the Wet Contacts are bridged.

At an elevation of 3,001 feet (916 meters), depth calibration automatically changes from feet of seawater to feet of fresh water. This is the first adjustment to the Algorithm.

When the Conservative Factor feature is set On, allowable dive times are calculated based upon the next higher 3,000 foot (915 meter) Altitude. All adjustments for Altitudes greater than 11,000 feet (3,355 meters) are then made to allowable dive times for 14,000 feet (4,270 meters). If the Conservative Factor is set On while at Sea Level, calculations are based upon an Altitude of 3,000 feet.

The Grande will not function as a Dive Computer above 14,000 feet (4,270 meters).

.....

DSAT ALGORITHM >> NDLS (HR:MIN) AT ALTITUDE (IMPERIAL)

	SEA	EL-2	EL-3	EL-4	EL-5	EL-6	EL-7	EL-8	EL-9	EL-10	EL-11	EL-12	EL-13
Altitude (feet)	0 to 3000	3001 to 4000	4001 to 5000	5001 to 6000	6001 to 7000	7001 to 8000	8001 to 9000	9001 to 10000	10001 to 11000	11001 to 12000	12001 to 13000	13001 to 14000	>14000
Depth (FT)													
30 4:20	3:21	3:07	2:55	2:45	2:36	2:28	2:21	2:15	2:10	2:04	1:58	0:00	
40	2:17	1:43	1:36	1:30	1:25	1:20	1:16	1:12	1:09	1:06	1:03	1:01	
50	1:21	1:03	1:00	0:58	0:55	0:52	0:48	0:45	0:43	0:41	0:39	0:37	
60	0:57	0:43	0:40	0:38	0:36	0:34	0:33	0:31	0:30	0:29	0:28	0:27	
70	0:40	0:31	0:30	0:28	0:27	0:26	0:24	0:23	0:22	0:20	0:19	0:18	
80	0:30	0:24	0:23	0:21	0:20	0:19	0:18	0:17	0:16	0:16	0:14	0:13	
90	0:24	0:19	0:18	0:17	0:16	0:15	0:14	0:13	0:12	0:11	0:10	0:10	
100	0:19	0:15	0:14	0:13	0:12	0:11	0:10	0:10	0:09	0:09	0:08	0:08	
110	0:16	0:12	0:11	0:10	0:09	0:09	0:08	0:08	0:08	0:07	0:07	0:07	
120	0:13	0:09	0:09	0:08	0:08	0:08	0:07	0:07	0:07	0:06	0:06	0:06	
130	0:11	0:08	0:08	0:07	0:07	0:07	0:06	0:06	0:06	0:06	0:05	0:05	
140	0:09	0:07	0:07	0:06	0:06	0:06	0:06	0:05	0:05	0:05	0:05	0:05	
150	0:08	0:06	0:06	0:06	0:05	0:05	0:05	0:05	0:05	0:04	0:04	0:04	
160	0:07	0:06	0:05	0:05	0:05	0:05	0:05	0:04	0:04	0:04	0:04	0:04	
170	0:07	0:05	0:05	0:05	0:04	0:04	0:04	0:04	0:04	0:04	0:04	0:03	
180	0:06	0:05	0:05	0:04	0:04	0:04	0:04	0:04	0:04	0:03	0:03	0:03	
190	0:05	0:04	0:04	0:04	0:04	0:04	0:04	0:03	0:03	0:03	0:03	0:03	

DSAT ALGORITHM >> NDLS (HR:MIN) AT ALTITUDE (METRIC)

SEA	EL-2	EL-3	EL-4	EL-5	EL-6	EL-7	EL-8	EL-9	EL-10	EL-11	EL-12	EL-13	
<u>Altitude</u> (meters) to	916	1221	1526	1831	2136	2441	2746	3051	3356	3661	3966	> 4270	
915	1220	1525	1830	2135	2440	2745	3050	3355	3660	3965	4270		
<u>Depth</u> (M)													
9	4:43	3:37	3:24	3:10	2:58	2:48	2:39	2:31	2:24	2:18	2:12	2:07	0:00
12	2:24	1:52	1:44	1:37	1:30	1:25	1:21	1:17	1:13	1:10	1:07	1:04	
15	1:25	1:06	1:03	1:00	0:57	0:55	0:52	0:49	0:46	0:43	0:41	0:39	
18	0:59	0:45	0:42	0:40	0:38	0:36	0:34	0:32	0:31	0:30	0:29	0:28	
21	0:41	0:33	0:31	0:29	0:28	0:27	0:26	0:24	0:23	0:21	0:20	0:19	
24	0:32	0:26	0:24	0:22	0:21	0:20	0:19	0:18	0:17	0:16	0:15	0:14	
27	0:25	0:19	0:18	0:17	0:16	0:16	0:14	0:13	0:12	0:12	0:11	0:10	
30	0:20	0:16	0:15	0:13	0:12	0:12	0:11	0:10	0:10	0:09	0:09	0:08	
33	0:17	0:12	0:11	0:11	0:10	0:09	0:09	0:08	0:08	0:08	0:07	0:07	
36	0:14	0:10	0:09	0:09	0:08	0:08	0:07	0:07	0:07	0:06	0:06	0:06	
39	0:11	0:08	0:08	0:07	0:07	0:07	0:06	0:06	0:06	0:06	0:05	0:05	
42	0:09	0:07	0:07	0:07	0:06	0:06	0:06	0:05	0:05	0:05	0:05	0:05	
45	0:08	0:06	0:06	0:06	0:06	0:05	0:05	0:05	0:05	0:05	0:04	0:04	
48	0:07	0:06	0:06	0:05	0:05	0:05	0:05	0:04	0:04	0:04	0:04	0:04	
51	0:06	0:05	0:05	0:05	0:05	0:04	0:04	0:04	0:04	0:04	0:04	0:04	
54	0:06	0:05	0:05	0:04	0:04	0:04	0:04	0:04	0:04	0:03	0:03	0:03	
57	0:05	0:04	0:04	0:04	0:04	0:04	0:04	0:03	0:03	0:03	0:03	0:03	

OXYGEN EXPOSURE LIMITS

(from NOAA Diving Manual)

PO2 (ATA)	Max Duration Single Exposure		Max Total Duration 24 Hour Day		PO2 (ATA)	Max Duration Single Exposure		Max Total Duration 24 Hour Day	
	(min)	(hr)	(min)	(hr)		(min)	(hr)	(min)	(hr)
0.60	720	12.0	720	12.0	1.20	210	3.5	240	4.0
0.70	570	9.5	570	9.5	1.30	180	3.0	210	3.5
0.80	450	7.5	450	7.5	1.40	150	2.5	180	3.0
0.90	360	6.0	360	6.0	1.50	120	2.0	180	3.0
1.00	300	5.0	300	5.0	1.60	45	.75	150	2.0
1.10	240	4.0	270	4.5					

SPECIFICATIONS

CAN BE USED AS

- Watch
- Dive Computer (Air or Nitrox)
- Digital Depth Gauge/Timer
- Free Dive activity

NO DECOMPRESSION MODEL

Basis:

- Modified Haldanean Algorithm
- 12 tissue compartments

Data Base:

- Diving Science and Technology (DSAT) - Rogers/Powell

Dive Computer Performance:

- Tissue compartment halftimes (mins.) Spencer's "M" values 5, 10, 20, 40, 80, 120, 160, 200, 240, 320, 400, 480
- 60 minute surface credit control for compartments faster than 60 minutes
- Tissue compartments tracked up to 24 hours after last dive

Decompression Capabilities (stop ceilings):

- 10, 20, 30, 40, 50, and 60 FT
(3, 6, 9, 12, 15, and 18M)

Altitude Algorithm and Oxygen Exposure Limits:

- Based on NOAA tables

NORM/GAUG SET MODES

- | | |
|--|--|
| • <u>Set F:</u>
FO2
FO2 Default | <u>Factory Settings:</u>
Air
On |
| • <u>Set A (Alarms):</u>
Audible
Depth
EDT
NIBG
DTR
PO2 | <u>Factory Settings:</u>
On
330 FT
3:00 (hr)
5 (Deco)
:20 (min)
1.60 ATA |
| • <u>Set U (Utilities):</u>
Wet Activation
Units
Deep Stop
Safety Stop
Conservative Factor
Backlight Duration
Sampling Rate | <u>Factory Settings:</u>
On
Imperial
Off
Off
Off
:05 (sec)
15 (sec) |
| • <u>Serial Number</u> | Factory set |

SPECIFICATIONS (CONTINUED)

NUMERIC DISPLAYS:

<u>NUMERIC DISPLAYS:</u>	<u>Range:</u>	<u>Resolution:</u>
• Time of Day	0:00:00 to 23:59:59 hr:min:sec	1 second
• Watch Countdown Timer	23:59 to 0:00 hr:min	1 minute
• Watch Chronograph	0:00:00.00 to 9:59:59.99 hr:min:sec.1/100 sec	1/100 second
• Temperature	0 to 140°F (-9 to 60°C)	1°
• Surface Interval Time	0:00 to 23:59 hr:min	1 minute
• Dive Number	0 to 24	1
• Current Depth	0 to 330 FT (100 M)	1 FT (.1 M)
• Maximum Depth	330 FT (100 M)	1 FT (.1 M)
• FO2	Air, 21 to 50 %	1 %
• PO2	0.00 to 5.00 ATA	.01 ATA
• Dive Time Remaining	0:00 to 9:59 hr:min	1 minute
• Total Ascent Time	0:00 to 9:59 hr:min	1 minute
• Deep Stop Time	2:00 to 0:00 min:sec	1 second
• Safety Stop Time	5:00 to 0:00 min:sec	1 second
• Deco Stop Time	0:00 to 9:59 hr:min	1 minute
• Elapsed Dive Time	0:00 to 9:59 hr:min	1 minute
• Time to Fly	23:50 to 0:00 hr:min* (* starting 10 min after the dive)	1 minute
• Time to Desaturate	23:50 max to 0:00 hr:min* (* starting 10 min. after the dive)	1 minute
• Out of Range (---)	=> 330 FT (100 M)	
• Violation Countdown Time	23:50 to 0:00 hr:min	1 minute
• Free Surface Interval Time	0:00 to 59:59 min:sec 1:00 to 23:59 hr:min	1 second 1 minutes
• Free Dive Number	0 to 99	1
• Free Countdown Timer	59:59 to 0:00 min:sec	1 second
• Free Elapsed Dive Time	0:00 to 59:59 min:sec	1 second

SPECIFICATIONS (CONTINUED)

BAR GRAPH

Nitrogen Bar Graph:

- No Decompression zone
- Decompression zone

segments

- 1 to 4
- 5 (all)

Oxygen (O2) Bar Graph:

- Normal zone
- Danger zone

segments

- 1 to 4
- 5 (all)

OPERATIONAL PERFORMANCE

Function:

- Depth
- Timers

Accuracy:

- ±1% of full scale
- 1 second per day

Dive Counter:

- NORM/GAUG numbers/displays Dives #1 to 24, FREE numbers Dives #1 to 99, 0 if no dive made yet
- Resets to Dive #1, upon diving (after 24 hours with no dives)

NORM/GAUG Dive Log Mode:

- Stores 24 most recent NORM/GAUG dives in memory for viewing
- After 24 dives, adds 25th dive in memory and deletes the oldest dive

Altitude:

- Operational from sea level to 14,000 feet (4,270 meters) elevation
- Measures ambient pressure every 30 minutes in Watch Mode and when Dive Computer Mode is accessed, every 15 minutes while in NORM/GAUG/FREE Surface Modes.
- Does not measure ambient pressure when Wet.
- Compensates for Altitudes by adjusting depth and nitrogen calculations when above sea level beginning at 3,001 feet (916 meters) elevation and every 1,000 feet (305 meters) higher.

Conservative Factor:

- Reduces NORM/FREE NDLS to those for the Altitude 3,000 feet (915 meters) higher.

SPECIFICATIONS (CONTINUED)

Power:

- Battery 1 - 3 vdc, CR2430, Lithium battery
- Shelf life Up to 7 years (when shipped from factory in Deep Sleep mode)
- Replacement User replaceable (annual recommended)
- Use Life 1 year or 300 dive hours if 2 - 1 hour dives per dive day

Battery Indicator:

- Warning - icon on solid < 2.75 volts > 2.50 volts, Battery change recommended
- Alarm - icon on flashing at <= 2.50 volts, change the Battery, will not function as a DC

Dive Computer Mode Activation:

- Manual - push button (recommended), required if Wet Activation is set OFF.
- Automatic - by immersion in water (if set ON)
- Graphic WET indicates Activation Contacts are Wet (unit must be dried prior to transport or storage)
- Cannot be manually activated deeper than 4 FT (1.2 M), if Water Activation is set OFF.
- Cannot operate as a Dive Computer at elevations higher than 14,000 feet (4,270 meters)
- Reverts to Main Time if no dive is made within 2 hours after entry into a Surface Mode.
- Reverts to Main Time 10 minutes after surfacing from dives.

Operating Temperature:

- Out of the water - between 20 °F and 140 °F (-6 and 60 °C).
- In the water - between 28 °F and 95 °F (-2 and 35 °C).
- At extremely low temperatures, the LCD may become sluggish, but this will not affect it's accuracy. If stored or transported in extremely low temperature areas (below freezing), you should warm the unit and its battery with body heat before diving.

Storage Temperature:

- Out of the water (in storage container) - between 14 °F and 158 °F (-8 and 70 °C).



WARNINGS:

- Ensure that you know which Operating Mode is selected (NORM, GAUG, or FREE) prior to commencing any dive.
- Conducting Free dives within a 24 hour period after conducting SCUBA dives, combined with the effects of multiple rapid Free Dive ascents, increases your risk of decompression sickness. Such activities may result in accelerated entry into decompression which could cause serious injury or death.
- Combining competitive type Free dive activities that involve multiple descents/ascent with activities utilizing SCUBA during the same 24 hour period is not recommended. Presently, there is no data relating to such activities.
- It is highly recommended that anyone planning to become involved in competitive type Free dive activities obtain proper instruction and training from a recognized Free Diving trainer. It is imperative that the physiological affects be understood and the diver is physically prepared.
- If your Grande stops working for any reason while operating as a Dive Computer, it is important that you have anticipated this possibility and are prepared for it. This is an important reason for not pushing the no decompression and oxygen exposure limits, and a critical reason to avoid entering decompression. If you dive in situations where your trip would be ruined or your safety would be jeopardized by losing the use of your Grande, a backup instrument system is highly recommended.

ADDITIONAL INFORMATION PERTAINING TO FREE DIVE MODE:

Although breathing apparatus is not utilized for FREE Dive activities, nitrogen tissue loading remains a factor. Nitrogen loading is calculated based upon a fixed FO₂ of AIR. Since a user has the option of alternating between NORM (SCUBA) and FREE Dive activities within a 24 hour period, nitrogen calculations and the displayed value of No Deco Dive Time Remaining (NDC Time) are carried over from one operating mode to the other, which permits the user to maintain awareness of nitrogen absorption and offgasing status. The mathematical model currently used in the Grande is based on no decompression/decompression multilevel repetitive dive schedules. This algorithm does not take into account the physiological changes associated with the high pressures that competitive type Free diving can expose a diver to.

INSPECTION / SERVICE RECORD

Serial Number: _____

Firmware Revision: _____

Date of Purchase: _____

Purchased from : _____

Below to be filled in by an Authorized Bism Dealer:

Date	Service Performed	Dealer / Technician

GRANDE

Operating Manual