



JA(Air) BC

OPERATION MANUAL

Instruction

Thank you for purchase of our product.
 This operating manual is the guidebook to provide instructions on how to use your buoyancy compensator (B.C.), Air, for recreational diving.
 We believe this manual is useful in mastering technology of a B.C. for people who have learned the right usage of a B.C. and obtained a C-card through proper training at a diving instruction organization as well as people who use it at C-card training. Please carefully read and digest the contents of this manual before use. We also suggest that you take this manual with you to refer to before diving.
 Keep this manual in a safe place. If you lose it, contact your original dealer or authorized distributor of our company. A replacement manual will be reissued later.
 The main contents consist of assembly of B.C., setting to a tank, the check before use, usage, care after use, storage, and a periodic inspection.
 B.C. Air is diving gear to use in combination with a regulator for recreational diving. Therefore, the knowledge of the right handling of regulator is also necessary. Please use the operating manual of the regulator which you use as well as this manual of Air.
 In addition, depending on the model of regulator, it is considered not being suitable for the use by the combination with this product. We recommend you use by the combination with the regulator made by Bism.
 We are constantly researching and improving our B.C., and so the product you purchased may differ in certain details from the one described in this manual. If you have any queries regarding your B.C. or the information contained in this manual, please feel free to contact our company at the address below.

Bism CORPORATION
 5F, 3-6-18, Higashinohonbashi, Chuo-ku, Tokyo 103-0004 Japan
 Phone: +81-3-5640-8126 Fax: +81-3-5640-8131
 E-mail: info@bism.co.jp URL: http://www.bism.co.jp

CONTENTS

Introduction	1
▲ Important Information	2
▲ Precautions	2
Name of parts	3
Special Features & Specifications	4
Assembly	5
Before Setting to a Tank	6
Setting to a Tank	7
Installation of B. C. Hose	7
Basic Operation of Air Supply · Exhaust & Actuation Check	8
Put on · Take off	10
Basic Usage	11
2 Way Inflator	12
Strage Pocket	12
Remove a B. C. from a Tank	13
Wash & dry	13
Storage, Periodic Inspection & Service after the Sales	14
Troubleshooting	15

IMPORTANT INFORMATION

Purpose of Use

This product is diving gear for recreational diving use.

The connection with a regulator allows the use and is buoyancy compensator “adjusting neutral buoyancy” at the time of recreational diving.

PRECAUTIONS

In order to use B. C. safely, the right operation, periodical maintenance and check are indispensable. Carefully read the advice on safety given in this manual before diving.

As the indication in this manual and to the product, in order to use the product safely and correctly, and to prevent the danger and the damage to the property of you or other people beforehand, various marks are used.

The indication and the meaning are as follows.

Danger

Danger indicate a great risk of death or serious injury from improper use.

Warning

Warning indicate a risk of death or serious injury from improper use..

Caution

Caution indicate a risk of minor injury or damage to property from improper use.

[Note] Useful Information to know.

Danger

- Use this product after having obtained a C-card and completing a proper training program at an internationally recognized diving school, and be familiar with diving gears, or under the instruction of the diving school. Otherwise it may cause an accident resulting in injury or death.
- Please be sure not to dive alone by any means, but to respect buddy system. Single diving may lead to a serious accident and is very dangerous.
- Please be sure to recognize all the handling method, the warning and the instructions with this manual before using this product. In addition, please use it in the ocean after understanding how to use.
- Do not use this product for any purpose other than recreational diving. In particular, please do not use it as a lifesaver or a float. Air may fall out and it may cause to be drowned.
- If this product starts to function abnormally, stop use immediately and consult with your original dealer or authorized distributor of our company.

Warning

- When you perform scuba diving, please carry out by good health condition. When you feel uneasy in condition, please do not push yourself and stop diving.
- Before performing scuba diving, please avoid to take alcohol and medicine, and the one who is in bad physical condition or with a chronic disease should see a doctor for diagnosis in advance.
- This product is designed on the basis of a general healthy person who has average physical strength. Divers need to plan and execute a safe diving which suited for them, respectively.
- Please do not put weight into a side pocket. Not only it causes the trouble of the pocket, but also it becomes difficult to remove weight in emergency and may cause an accident resulting in injury or death.
- Please adjust the weight so that you can keep the neutral buoyancy on the surface while being in the state that air is exhausted completely from a float before diving. It may cause an accident resulting in injury or death by uncontrolled descent.
- Please do not fold or pull a hose. It not only breaks, but it may cause an accident resulting in injury or death.
- Please do not carry out usage that you ascend by using the buoyancy of the air supplied as a lifting bag. You may get decompression sickness by rapid ascent.
- Please do not jump from the high place more than 2m in the state that air is in the air cell. As big buoyancy is applied rapidly, not only B. C. breaks, but it may carry out an injury.

Caution

- If various solvents such as gasoline, spray liquid and cleaner such as cosmetics, and acid and alkali adhere, deterioration may be occurred. Please be careful enough so that these do not attach to the body and a hose.
- Please use B. C. of the size which fits your body type. Otherwise, you may lose balance in the water and it causes a decrease in performance.
- Though the product can withstand the shock in the usual use, drops and hard knocks may damage it.
- In the case of wearing to the bare skin, weak skin and the allergic tendency may get a rash. When you get a rash, stop wearing of the B. C., and consult with a medical specialist of dermatology.
- Since it may become a safety problem, please do not modify the product. Responsibility cannot be taken about the trouble after modification.

NAMES OF PARTS

At the Time of Assembly

■JA3620



At the Time of Buckle Release / Back and Other.

■JA3610 (The name of each parts is the same in other models.)

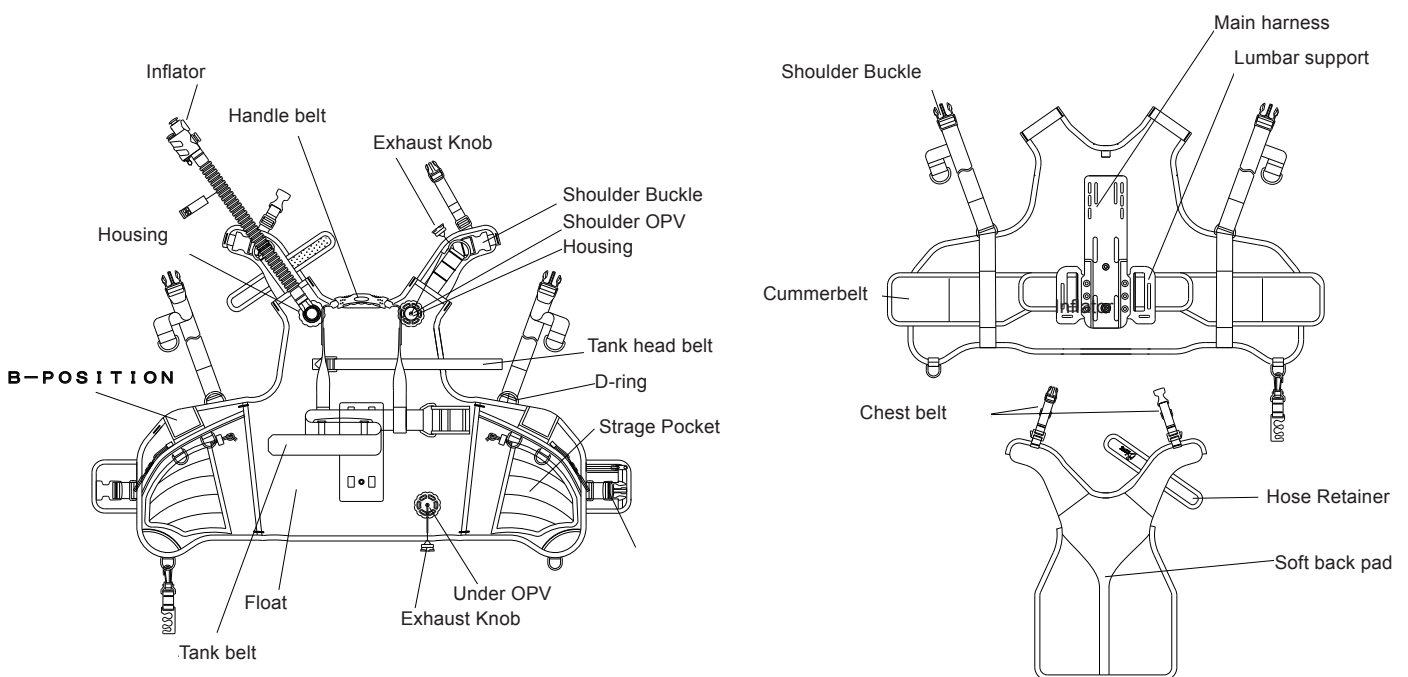

NAMES OF PARTS

Inflator

■Combination Valve II



■Standard Valve



For OCT2, please refer to the separate instruction manual.

Attachments

Please confirm before using this product. Refer to the page in () for the detailed explanation.

■B. C. Hose (1 piece), Hose Guard (1 piece).
Connect to a regulator first stage. (Page 5)

■Operating Manual (1 copy)



MAIN FUNCTIONS & FEATURES

Special Features

■Adjustment Mechanism of Cummerbelt Length (Page 6)
●Cummerbelt length at the waist portion is adjustable.

■Long Tank Buckle (Page 6)
The long tank buckle which you can fix to a tank without particular strong power is adopted.

■Easy Exhaust Operation (Page 8)
●The exhaust, power deflation, by the "OUT" button can be performed.
●The exhaust by the "ORAL" button is possible.
●When exhaust knob of a shoulder belt portion is pulled, the exhaust, quick deflation, from relief valve of a right shoulder can be performed.
●When remote control portion of the inflator is pulled, the exhaust from housing of a left shoulder, pull dump deflation, can be performed. (Standard valve only)
●When exhaust knob of a right waist portion is pulled, the exhaust, quick deflation, from relief valve of a right waist is possible.

■Adoption of Quick Release Shoulder Buckle. (Page 9)
The quick release buckle which can easily loosen a shoulder belt with only a thumb is adopted.

■H. f. s. Float Structure is Adopted.
When air is supplied to a B. C., the float structure which inflates so that the body may be wrapped in by the effect of a special shape rib is adopted.

■2 Way Inflator is Adopted. (Page 13)
The 2 way inflator system which can also turn a corrugated hose from the back side to use is adopted.

■Adoption of Waist Curve Line.
The waist curve line which fits the body easily by making a curve around the waist is adopted.

■Adoption of Thin Harness.
The newly-designed thin harness which distributes weight appropriately by bringing a tank close to your body is adopted.

■Adoption of Strage Pocket. (Page 12)
Function of functionality and design that suits the diver's style. This is a new strage system designed for ease of use.

■Adoption of B-POSITION (Page 12)
The B-POSITION installed on the left and right is effective for the back position of the 2WAY inflator and in holding the octopus.

MAIN FUNCTIONS & FEATURES

Specifications

Body

The maximum buoyancy: XS: 117N (12kgf), S: 137N (14kgf), M: 157N (16kgf), L: 196N (20kgf)
 Weight: XS:2.7kg, S:2.8kg, M:2.9kg, L:3.0kg
 Length of beltline ; 55 cm - 100 cm
 Temperature range ; -5 - +50°C
 Material: Thermo-plastic coating cloth
 Basic cloth: Nylon
 Back side: Polyurethane

Hose Portion

Material: Inner tube ; Vinyl chloride
 Outer cover ; Vinyl chloride
 Coupling ; Copper alloy
 Outer diameter ; 13 mm
 Hose length ; 700 mm
 Nominal size of coupling threads ; 3/8-24UNF
 Maximum operating pressure ; 15 bar
 Minimum bending radius (Inside of hose) ; 115 mm
 Hose guard ; Regular equipment

Combination Valve II

Corrugated hose length: 550 mm
 (Length from the center of housing to the end of an oral button)
 Weight: 394 g
 Air supply flow: 80 liter/minute

Standard Valve

Corrugated hose length: 540 mm
 (Length from the center of housing to the end of an oral button)
 Weight: 366 g
 Air supply flow: 100 liter/minute

Relief Valve

Position: One in right shoulder, one in right waist portion.
 Exhaust operation pressure at the time of over pressure:
 0.2 bars or less.
 Tensile force necessary for quick deflation:
 9.8 - 14.7 N (1 - 1.5kgf)

Float Explosion Prevention Equipment

Relief Valve

When air has been supplied to float of B. C. excessively by mistake, in order to prevent the burst, if internal pressure of float exceeds certain pressure, it is in structure to open the relief valve automatically and release air from housing.

ASSEMBLY

Install B.C. Hose to a Regulator

Warning

- Please install the hose in the state that the first stage of a regulator is not connected to a tank. If the first stage is pressurized during work, a plug in the port flies and it is dangerous.
- Please use the regulator with the first stage having L. P. port thread of 3/8-24UNF as nominal size. Otherwise, not only it causes the damage of equipment, but also a hose comes off and it may cause an accident resulting in injury or death.
- Please confirm that O-rings are set at the threads portion of each B. C. hose.
 When there are no O-rings, it causes the air leakage.
- Do not install the B. C. hose to an H. P. (High Pressure) port.

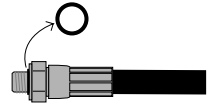

Caution

- When you tighten hose couplings with a spanner, please keep the tightening torque of 9.8N/m (100kgf/cm). Otherwise it may cause to damage the threads portion.
- Please do not attach hose guards other than our products to a B.C. hose.

- 1 Please remove the plug from the L. P. (Low Pressure) port of the first stage of a regulator.

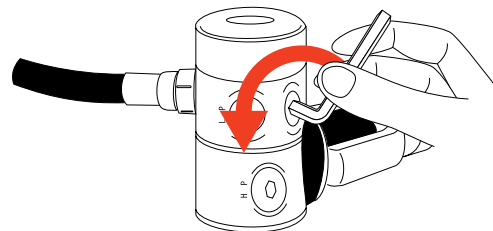

- 2 Please screw in the coupling of a B. C. hose to L. P. port and turn it clockwise with a spanner to tighten it. Tightening torque is 9.8 N / m (100 kgf / m).

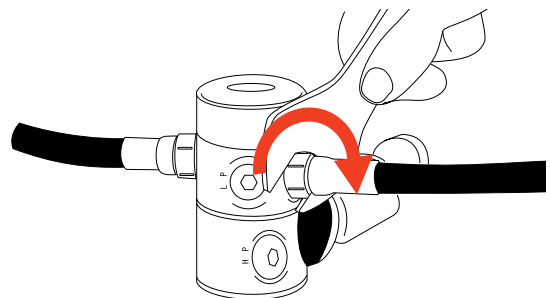

[Note]

- If you are not familiar with the installation work, please ask your original dealer or the authorized distributor of our company for installation of hoses.

BEFORE SETTING TO A TANK

Check of B.C. Hose

Please check whether the hose is damaged or has broken.

⚠ Warning

- If there is an abnormality in your B. C. hose, you must not use it.
- When there is an abnormality, stop to use it and contact your original dealer or authorized distributor of our company.

Adjust Cummerbelt Length

⚠ Warning

- Please do not remove Velcro tape which connects harness and a side belt, and do not change width of the Velcro tape portion.
- Please wear your own diving suit and perform the length adjusting.

□ Shorten the length.

1 Take off soft back pad.

2 Remove the Velcro tape of a cummerbelt.

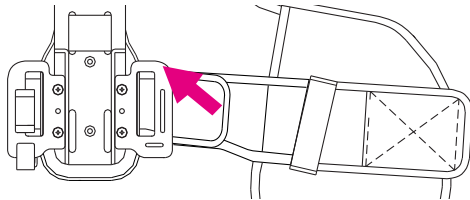

3 Pull out the belt as much as you want to shorten it. At this time, please be careful for the Velcro tape "Male" not to protrude from the Velcro tape "Female" by pulling out too much.

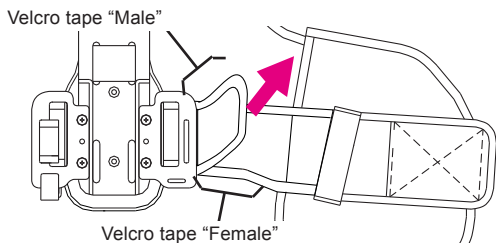

4 Press down the Velcro tape from the front and back side and stick together.

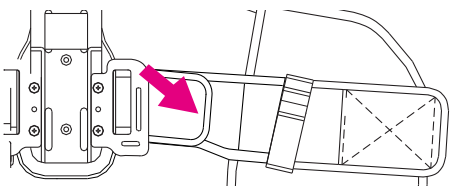

5 Install the soft back pad.

□ Lengthen the length.

1 Please perform like "1" and "2" of "Shorten the length", and send a belt to the direction to lengthen in "3". At this time, be careful for the Velcro tape "male" not to enter into the slit of harness by sending it too much.

2 Stick the Velcro tape together like in "4", and install the back pad like in "5".

[Note]

- A waist size changes a lot with the kinds of suit to wear. When the diving suit to wear is changed, please be sure to readjust the length.
- A cummerbelt is in each side of right and left. Please perform length adjustment for both cummerbelt.

SETTING TO A TANK

Install B.C. to a Tank

⚠ Warning

- Please put the tank on the stable place, such as the flat ground, at the time of setting. It is dangerous if it falls.
- Please be careful not to catch a handle belt between a tank and B. C. at the time of setting. Not only you cannot use a handle belt, but also a tank is not fixed firmly.

[Note]

- A handle belt is a handle for carrying the whole tank, after setting B. C. to a tank.

1 Slide a tank buckle and a belt pad in right and left over the belt so that their position may become close to the harness side. Pass a tank belt through the 2 slits of a tank buckle as shown in a figure, and make a tank belt ring large enough for a tank goes through.

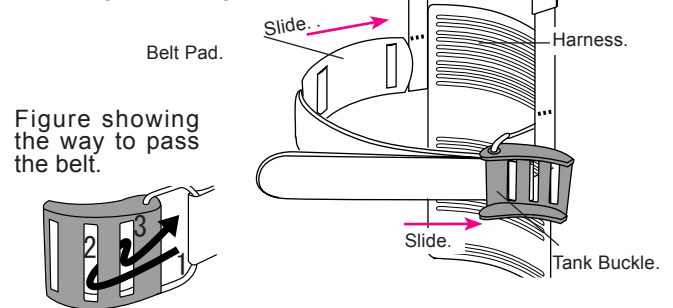
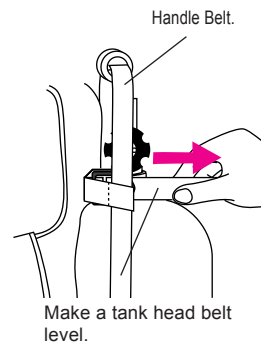

Figure showing the way to pass the belt.

2 Put the ring of a tank belt over the top of the tank. Set a direction of a tank so that the air exit side of a tank valve may turn to the back side at the time of wear.

Also, adjust the setting height of B.C. so that a tank head belt may be fixed at the lower portion of a tank valve in the level state, and then tighten it.

Be careful not to tighten a tank head belt too much at this time.



3 In the state that a tank buckle is set in direction of a figure, pull the end portion of a belt, and tighten a tank.

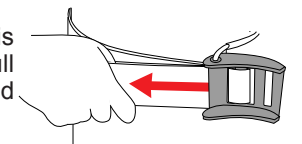

4 While pulling the end of the belt, turn the tank buckle. Stick the end of the belt to the Velcro portion of the belt.

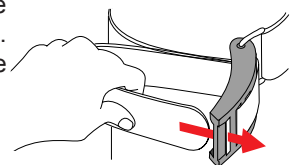

5 Having a tank belt, move it up and down and check whether the tank belt moves. If it moves, please start it again from the beginning. (Refer to page 17 for the way to remove.)

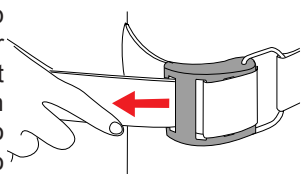

[Note]

- Install a B. C. to a tank before setting a regulator first stage.

INSTALLATION OF B.C. HOSE

Install a B.C. Hose

⚠ Warning

- When you perform the connecting work of a B. C. hose, close the tank valve, push the purge button of a regulator to release the pressurized air in a hose.

- 1 Install a regulator first stage to tank valve according to an operating manual of the regulator.
- 2 Connect a quick-coupler at the end of a B. C. hose to a nose while sliding a collar of the quick-coupler.

■JA3610
(Combination Valve)

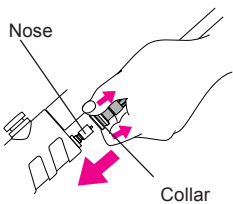

■JA3620
(Standard Valve)

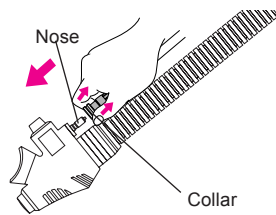

- 3 Grip the end of the quick-coupler and push it until it sounds "click".

■JA3610
(Combination Valve)

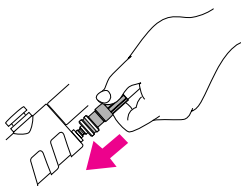

■JA3620
(Standard Valve)

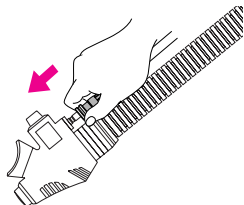

- 4 While pulling the quick-coupler by gripping the end of it, check whether it comes off. When it comes off, please start it again from the beginning.

Check the Connecting Portion of B.C. Hose

⚠ Warning

- If there is an air leakage from a connecting portion, do not use it.
- When the air leakage from a connecting portion does not stop, please consult with your original dealer or authorized distributor of our company.

Open a tank valve according to an operating manual of a regulator or a gauge. Touch the connecting portion with your fingers to check if air leaks or not. Also, check if you can hear the sound of air leakage,

If air leaks, once disconnect the quick-coupler and connect it again from the beginning after pushing a purge button of a regulator second stage to release air pressure in a hose, and then check air leakage again.

□Disconnect B.C. hose.

⚠ Warning

- Before disconnecting a quick-coupler of B.C. hose from inflator, be sure to close the tank valve, push the purge button of a regulator to release the pressurized air in a hose.

- 1 Close the tank valve, push the purge button of regulator second stage to release residual air in a hose.
- 2 Pull the collar of a quick-coupler at the end of a B. C. hose and disconnect from the nose while pulling the collar.

■JA3610
(Combination Valve)

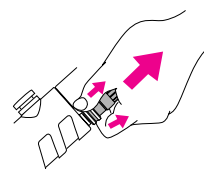

■JA3620
(Standard Valve)

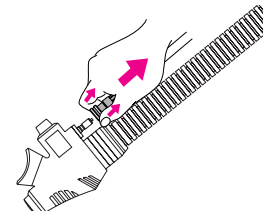

BASIC OPERATION OF AIR SUPPLY EXHAUST & ACTUATION CHECK

Inflator Operation of Air Supply · Exhaust & Actuation Check

⚠ Warning

- Air supply by the "IN" button of an inflator (Power Inflation) is performed only when an inflator is set up correctly and air is in a tank. Air is not supplied when there is not enough air.
- Please do not give a strong shock against an inflator. It causes of breakage and also operation failure.
- When abnormalities are found in the following check, please stop use and consult with your original dealer or authorized distributor of our company.

⚠ Caution

- Please do not continue exhaust operation in the state that there is no air in float of B. C. during diving. A lot of water may come in the float of B. C.

□ Actuation check (In the case of JA3610 combination valve)

⚠ Warning

- Exhaust by the "OUT" button is performed only when an inflator is set up correctly and air is in a tank. Air is not supplied when there is not enough air.
- Please do not pull combination valve. It causes of breakage and also operation failure.

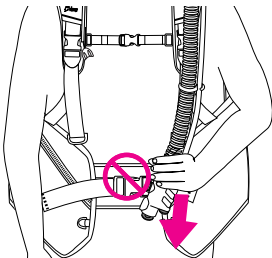

■ Air supply operation

- 1 "Power Inflation"
When you push "IN" button, air is supplied in the float. Check whether air is supplied in float only while pushing the button.

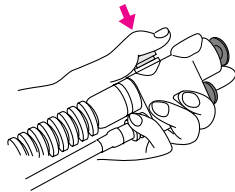

- 2 "Oral Inflation"
Hold a mouth piece of an inflator in your mouth firmly, if you push oral button only while blowing a breath, air is supplied into a float. Check whether air is supplied certainly.

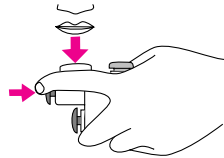

■ Exhaust operation

- 1 "Deflation by ORAL Button"
When "ORAL" button is pushed, the valve in the inflator will be released and the air in float will fall out through the mouth piece. Put air in a float about 80% and check whether air is exhausted only while you push the "ORAL" button.

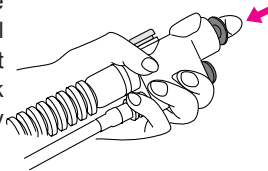

- 2 "Power Deflation"
When "OUT" button is pushed, the valve in the housing on a left shoulder will be released and the air in float will fall out. Put air in a float about 80% and check whether air is exhausted only while you push the button.

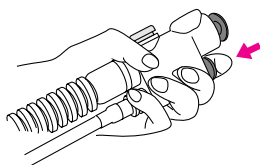

□ Actuation check (In the case of JA3620 standard valve)

■ Air supply operation

- 1 "Power Inflation"
When you push "IN" button, air is supplied in the float. Check whether air is supplied in float only while pushing the button.

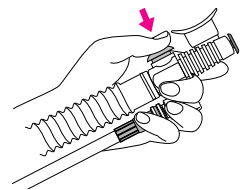

- 2 "Oral Inflation"
Hold a mouth piece of an inflator in your mouth firmly, if you push oral button only while blowing a breath, air is supplied into a float. Check whether air is supplied certainly.

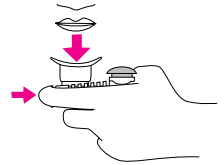

■ Exhaust operation

- 1 "Deflation by ORAL Button"
When "ORAL" button is pushed, the valve in the inflator will be released and the air in float will fall out through the mouth piece. Put air in a float about 80% and check whether air is exhausted only while you push the "ORAL" button.

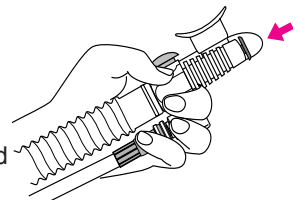

- 2 "Pull Dump Deflation"
Pulling down the inflator body will release the valve in the shoulder housing and let the air in the float exhaust. Put air in a float about 80% and check whether air is exhausted only while you pull the inflator.

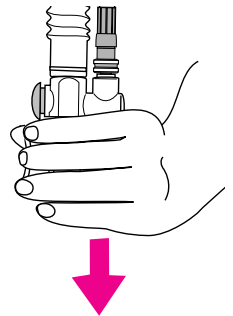

[Note]

- If you perform the exhaust with the "OUT" button (Power Deflation), a little air will be exhausted from the root of the "OUT" button, but it is not failure.
- Please refer to Page 11 for underwater exhaust operation.

[Note]

- Please refer to Page 11 for underwater exhaust operation.

BASIC OPERATION OF AIR SUPPLY EXHAUST & ACTUATION CHECK(Continued)

Exhaust Operation of Relief Valve & Actuation Check

⚠ Warning

- Do not use this product if it is not functioning normally.
- If you find any abnormality by the following check, please stop use and consult with your original dealer or authorized distributor of our company.

⚠ Caution

- In the case of the exhaust by a relief valve, if exhaust knob is pulled too strong, it will become a cause of breakage. The power which can open a valve is enough. Please check the proper level of power before use.

□ Visual check

Check whether the string of each shoulder and under exhaust knob is not being broken.

□ Actuation check

■ Exhaust actuation at the time of over pressure

- 1 Push the "IN" button and inflate a float.
- 2 Also, continue to push the "IN" button and confirm that air is automatically exhausted from a relief valve.

■ Exhaust operation by shoulder relief valve. "Quick Deflation"

When you pull an exhaust knob downward, a valve on a shoulder will be opened only while it is pulled, and the air in a float will be released through the relief valve on the right shoulder.

Put air in a float about 80% and check whether air is exhausted only while you pull the exhaust knob.

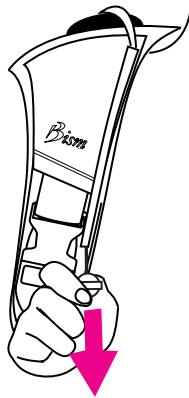

■ Exhaust operation by under relief valve. "Quick Deflation"

When you pull an exhaust knob downward, a valve on a waist will be opened only while it is pulled, and the air in a float will be released through the relief valve on the right waist.

Put air in a float about 80% and check whether air is exhausted only while you pull the exhaust knob.

[Note]

- In order to prevent the burst of a float when putting air too much in it, the role of a relief valve is to exhaust air automatically when the pressure inside float exceeds a fixed level.
- Please refer to Page 11 for underwater exhaust operation.

PUT ON · TAKE OFF (How to Use Shoulder · Waist Buckles)

Please learn how to use various buckles before actually wear the B.C.

⚠ Warning

- Please do not release various buckles of shoulder waist underwater. It may cause an accident resulting in injury or death.

How to Use Shoulder Waist Buckles

■ Accurate wearing state

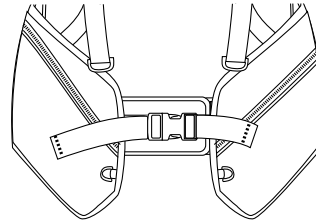

D-ring.

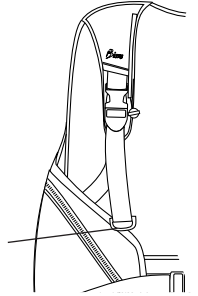

□ Release a buckle

When you press the center of a buckle with your fingers strongly as shown in a figure, the buckle will be released.

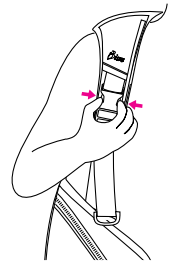
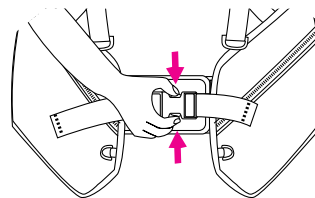

□ Fasten a buckle

When you insert male side of a buckle into the female side as shown in a figure, it will fit in with a sound of "click"

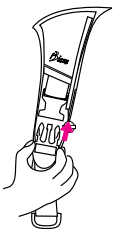
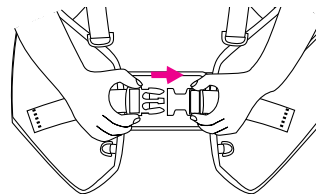

□ Lengthen a belt

Lift a buckle to the front, as shown in a figure, and lengthen a belt.

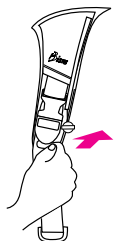
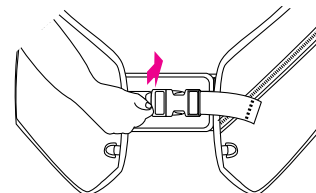

□ Shorten a belt

Just pulling down a D-ring, you can shorten a belt length. When you wear a B. C., pull down the D-rings at both sides simultaneously, and fit to your body.

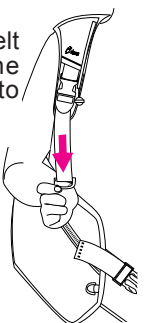
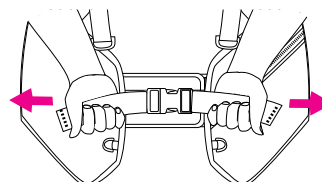

PUT ON · TAKE OFF (Continued)

⚠ Warning

- Please wear B. C. in the place where is no body except your buddy who helps you to wear it. Tanks hit each other and it becomes the accident.
- Wear B. C. in the state that the shoulder buckles on both shoulder are fastened. Wearing it while the buckles are released, the whole tank and B. C. may be dropped and dangerous.

Take Off a B. C.

- 1 Release a buckle of chest belt and waist buckle, and also tear off the Velcro tape of a cummerbelt.
- 2 Hold one of the shoulder belts firmly by the hand of the same side. Release the buckle of the other side of shoulder belt by the other hand.

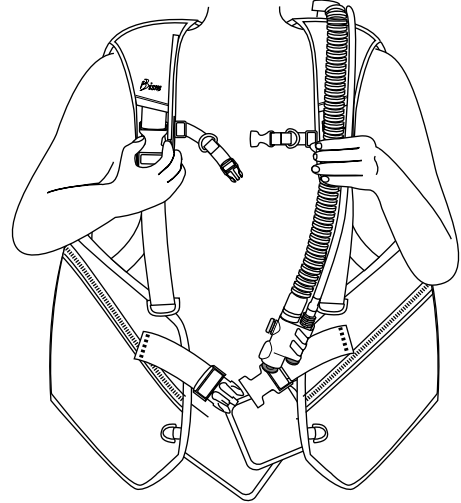

- 3 Swing a tank around to the front of you while holding the shoulder belt by one hand, and place the tank on the ground by keeping it with the other hand.

Carry a B. C. on the Back

- 1 Slightly lengthen a belt in the state that the shoulder buckles on both right and left shoulders are fastened. Release a buckle of a waist belt, tear off the Velcro tape of a cummerbelt, and also loosen the belt. Moreover, move the hoses to the tank side so that they may not twist together.

- 2 Slip into the B. C. jacket and carry it on the back.

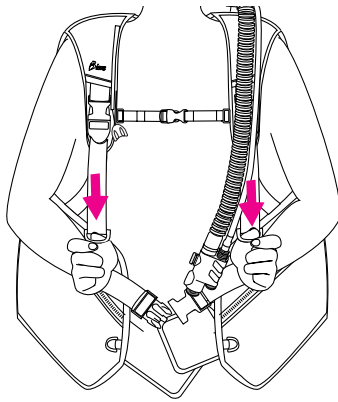

- 3 Pull down the D-rings of shoulder belts at both sides simultaneously, and fit to your body.

- 4 Stick the Velcro tapes of a cummerbelt together and fasten the waist buckle.

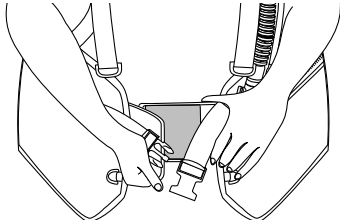

- 5 Pull down the end of waist belts at both sides simultaneously, and fit to your body.

- 6 When you insert male side of a buckle into the female side, it will fit in with a sound of "click".

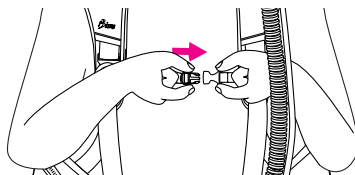

- 7 Eliminate the slack of the belt.

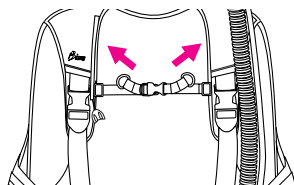

BASIC USAGE

Supply Air to a B.C.

⚠ Warning

- Do not perform air supply by pushing "ORAL" button underwater. You drink water by mistake, and it may cause an accident resulting in injury or death.
- Air supply by the "IN" button of an inflator is performed only when air is in a tank. Air is not supplied when there is not enough air.

[Note]

- If you continue to supply air to a B. C. which is already full of air, in order to prevent the burst of float, it has structure which releases air from a relief valve.

- Supply air by "IN" button. (Underwater and surface)

When you push "IN" button, air is supplied to a B.C.

- Supply air by "ORAL" button. (Surface only)

In the state of keeping enough buoyancy by a fin kick, hold a mouth piece of an inflator in your mouth firmly, push oral button only while blowing a breath, and supply air into a float.

Exhaust Air of a B.C.

- JA3610 combination valve)

⚠ Warning

- When an inflator is not set up correctly such as, B. C. hose is not installed correctly, tank valve is closed, air pressure in a tank is not enough, exhaust by the "OUT" button cannot be performed.

[Note]

- Exhaust by the "OUT" button is performed only when a low pressure hose of B. C. is set up correctly and tank valve is opened.

- Exhaust air by "OUT" button.

Take a posture so that the position of the housing of the left shoulder becomes the most top of a float (vertical posture), and then push the "OUT" button at hand, air will be exhausted from the housing.

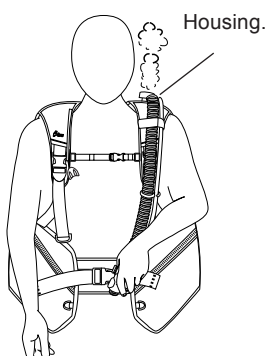

- JA3620 standard valve)

⚠ Warning

- When exhausting with the inflator pulled downward (pull dump deflation), if it is pulled too hard, it may cause damage and malfunction, and exhaust may not be possible.

[Note]

- Exhaust by pulling the inflator downward is possible even when the regulator is not attached to the tank.

- Exhaust air by pull dump.

Take a posture so that the position of the housing of the left shoulder becomes the most top of a float (vertical posture), and then pull the remote-control portion, air will be exhausted from the housing of the left shoulder.

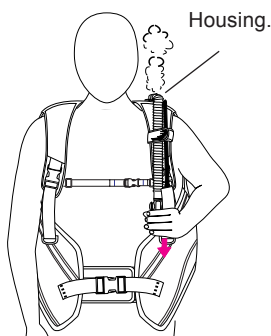

■ Common

- Exhaust air by "ORAL" button.

Take a posture so that the position of the housing of the left shoulder becomes the most top of a float (vertical posture), and then push the "ORAL" button while facing an inflator toward surface, air will be exhausted from a mouth piece portion of inflator.

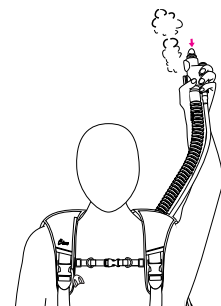

- Exhaust by exhaust knob.

■ In the case of a shoulder relief valve.

Take a posture so that the position of the relief valve of the right shoulder becomes the most top of a float (vertical posture), and then pull the exhaust knob, air will be exhausted from the relief valve of the right shoulder.

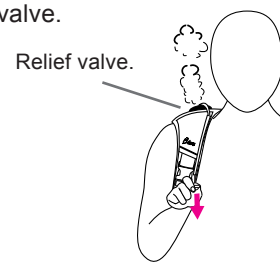

■ In the case of an under relief valve.

Take a posture so that the position of the relief valve of the right waist becomes the most top of a float (When head first etc.), and then pull the exhaust knob, air will be exhausted from the relief valve of the right waist.

2 WAY INFLATOR

Turn an Inflator from the Back Side.

⚠ Warning

- When you turn an inflator from a back side and use it, please do not fix a corrugated hose to the back side of the float. Air supply by the "ORAL" button becomes difficult, and it may cause an accident resulting in injury or death.

[Note]

- By turning and wearing an inflator from the back side, simple appearance without a corrugated hose in the left breast can be arranged.

- 1 Loosen the thread portion of a housing and remove the combination valve.

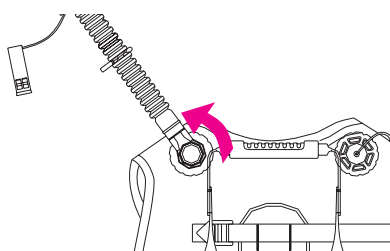

- 2 Place the combination valve upside down, adjust the angle of a convex and a concave portion which is 12 square shapes of a housing, and screw in.

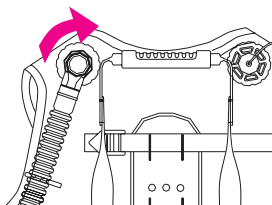

⚠ Warning

- Please adjust correctly the convex and concave portion of 12 angles of a housing, and screw in all the way. If 12 angles have shifted, it causes an air leakage. If screwing is insufficient, a housing comes off, and it may cause an accident resulting in injury or death.

- 3 Attach the corrugated hose of the combination valve to B-POSITION.

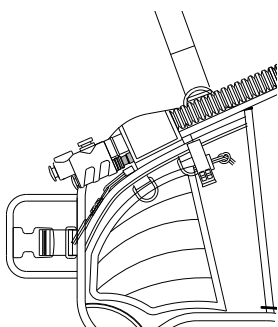

Strage Pocket

Adjust Stretch cord

⚠ Caution

The storage pocket is not a closed structure. Before using the product, take measures such as attaching a string to items so that it will not fall.

[Note]

Raise the pocket several times to even out the looseness.

Adjust the length of the stretch cord with the cord stopper according to the stored items.

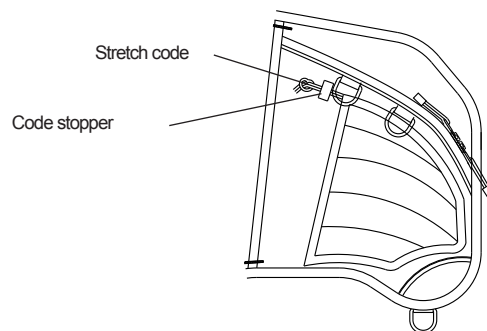

REMOVE B.C. FROM TANK

How to Remove a B. C. from a Tank

⚠ Warning

- When you remove a B. C. from a tank, please put the tank on the stable place, such as the flat ground. It is dangerous if it falls.

- 1 Close a tank valve, release the residual pressure inside of a hose by pushing the purge button of regulator second stage, and then disconnect the B. C. hose from a nose. (Refer to page 7)
- 2 Remove the regulator first stage from the tank.
- 3 Tear off the end of tank belt from a Velcro tape, and turn the buckle.

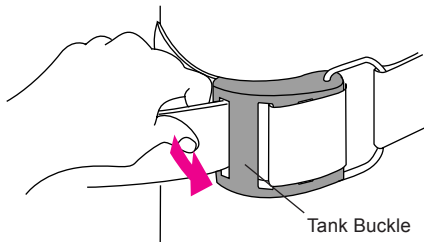

- 4 Draw a belt through the slot of the tank buckle.

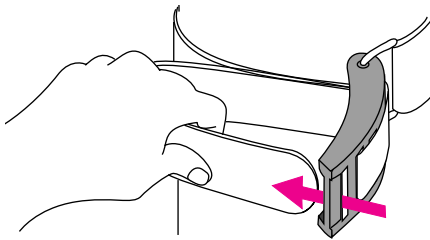

- 5 When you move the base of the tank buckle toward the direction of arrow, belt will be loosened.

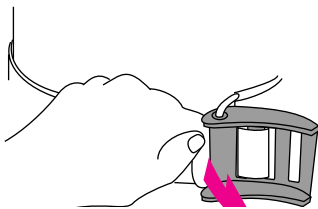

- 6 Tear off the Velcro tape of the tank head belt.

- 7 Loosen the tank belt, and remove the B. C. from upside of the tank.

[Note]

- Keep it in the state that a belt is not drawn from a tank buckle even after removing from B. C., it will make you easy for next setting.

WASH & DRY

Wash Outside

⚠ Caution

- Equipment may be damaged if soaked in hot water of 50°C or more.
- Please wash B. C. with fresh water immediately after use. If the salt attached dries and crystallizes, it causes an operation failure of a valve.

- 1 After soaking the whole equipment to fresh water for about 15 minutes, rinse the whole in water to wash the salt away.
- 2 Wash away each valve and inflator portion with fresh water well.

Wash Inside a Float

⚠ Caution

- Please do not push water out of the relief valve by using the pressure while putting air into B. C. It causes the damage.

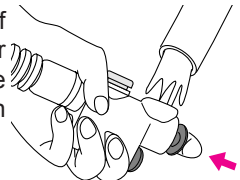
- 1 While pushing "ORAL" button of inflator, press a faucet of water service against a mouthpiece portion, and put fresh water in float about 1/4. 
- 2 After blowing air from the mouthpiece of an inflator to inflate B. C., shake the B. C. fully, and rinse the inside of float.

- 3 Hold B. C. so that the housing position of the base of an inflator hose may become the bottom, and also make an inflator position to the bottom, and drain the water inside of the float with air by pushing the "ORAL" button.
- 4 Repeat the above 1-3 process for 2 to 3 times.

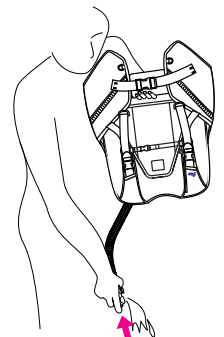

Wash Inside of a Valve. (JA3610)

- 1 Install regulator first stage to a tank, and connect the B. C. hose to an inflator.
- 2 Open a tank valve, push "OUT" button 4-5 times. Water inside a valve will be drained from the base of the "OUT" button.

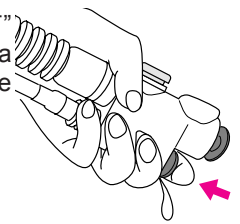

Dry

- 1 Inflate a B. C. by putting air in it about 80% through inflator mouthpiece.
- 2 Avoid direct rays, and dry the B. C. completely in the shade of dry and in good ventilation.

STORAGE & PERIODIC INSPECTION

Way of Storage

⚠ Caution

- Please keep the B. C. hose in a natural form. Over bending may cause a kinking and remarkably short service life.
- Please keep BC without folding. It shortens the service life of the float remarkably and causes the air leakage.



- Wash and dry the B. C. completely.
- Hang it on the hanger and keep it in the place with the dry, cool and sufficient ventilation where does not get sunshine.

Periodic Inspection

⚠ Warning

- Regardless of frequency and the number of times in use, please ask your original dealer or authorized distributor of our company for a periodic inspection per once in a year.
- Regardless whether or not you use it, a B. C. may not function normally when you ignore a periodic inspection.

[Note]

- Some parts carry out natural deterioration. Exchange of such parts is also performed by periodic check.
- Please ask your original dealer or authorized distributor of our company for a periodic inspection per once in a year. (Pay Service)

Service after the Sales

- When your B. C. is out of condition, check it first. Please refer to the clause of "Troubleshooting" and check whether it is failure.
- When it is still out of order; Please contact your original dealer or authorized distributor of our company.
- Reserving period of parts.

Our company reserves the performance parts (the parts required to maintain the function of the product) to repair B. C. for at least 8 years after the production is discontinued. Since repair may be possible depending on a problem even after this reserving period passes, please consult with your original dealer or authorized distributor of our company.

TROUBLE SHOOTING

Trouble	Major Cause	Measure	Page
It does not fit when wear it.	<ul style="list-style-type: none"> ○Length of cummerbelt at waist portion is not adequate. ○Length of shoulder belt is not sufficient. 	○Adjust the cummerbelt.	6
		○Adjust the shoulder belt.	9
B. C. cannot be fixed to a tank firmly	○The way of pass a belt through a buckle is wrong.	○Pass the belt through tank buckle correctly, and fix it.	6
BC does not inflate even if I push the "IN" button. (Air is not supplied)	<ul style="list-style-type: none"> ○B.C.hose is not connected correctly. ○Tank valve is not open. ○Air in a tank is not enough. ○You might push exhaust button at the same time. ○Relief valve is open. 	○Connect the B. C. hose correctly.	7
		○Open the tank valve.	-
		○Change to the tank with full of air.	-
		○Do not push exhaust button.	11
		○Do not pull exhaust knob.	-
BC does not inflate even if I perform the "Oral Inflation". (Air is not supplied)	<ul style="list-style-type: none"> ○You might push "OUT" button at the same time. ○Relief valve is open. ○The "ORAL" button is pushed at the time except blowing air. 	○Operate "ORAL" button only.	-
		○Do not pull exhaust knob.	11
		○Push "ORAL" button only at the time blowing air. (Refer to the course of a diving school)	8
Exhaust cannot be performed by "ORAL" button	○Posture is not appropriate.	○Perform button operation while taking a posture so that the position of the housing becomes higher than the float portion. (Refer to the course of a diving school)	11
BC does not exhaust even if I pull the exhaust knob.	○Posture is not appropriate.	○Perform the operation while taking a posture so that the position of the housing of the relief valve becomes the most top of a float.	11
Air leaks from a relief valve.	<ul style="list-style-type: none"> ○The pressure inside float exceeds a fixed level. ○A foreign object is stuck in the relief valve. 	○In order to prevent the burst of B. C. jacket, when inner pressure goes too high, it has structure which releases air.	-
		○Wash the valve with water well.	-
Air leaks from a mouth piece portion of an inflator.	○A foreign object is stuck in an oral valve.	○Wash the inside of inflator with water well.	13
Air leaks from a housing at the shoulder portion of inflator.	○A foreign object is stuck in an exhaust valve.	○Wash the housing portion with water well.	-
B.C. hose cannot be connected to an inflator.	<ul style="list-style-type: none"> ○Inside of the B.C. hose is pressurized. ○Thread size of hose coupling is not adequate as the B.C. hose is not Bism product. 	○Close the tank valve, release the air pressure in the hose by pushing the purge button of a regulator	8
		○Use the B. C. hose of attachment.	-
B.C. is abnormally heavy.	○Water is in side of a float.	○Drain the water in the float.	13
Buoyancy is insufficient.	○Weight is too heavy.	○Adjust to a reasonable weight.	-
BC does not exhaust even if I push "out" button.	<ul style="list-style-type: none"> ○B. C. hose is not connected correctly. ○Tank valve is not open. ○Air in a tank is not enough ○Posture is not appropriate. 	<ul style="list-style-type: none"> ○Connect the B. C. hose correctly. ○Open the tank valve. ○Change to the tank with full of air. ○Take a posture so that the position of the housing of the left shoulder becomes the most top of a float. 	-

