



S X (NELEUS)
 S K (re//brass)
 S B (Beans)
 S S (SUMERGE)
 Safety Second Junction

OPERATING MANUAL

Introduction

Thank you for purchase of our product.

This manual is the guidebook to provide instructions on how to use your single hose type safety second regulator (hereinafter just called safety second) of open circuit scuba for recreational diving, and B.C. hose integrated safety second regulator (hereinafter called junction) of open circuit scuba for recreational diving.

We believe this manual is useful in mastering technology of a regulator for people who have learned the right usage of a regulator and obtained a C-card through proper training at a diving instruction organization as well as people who use it at C-card training. Please carefully read and digest the contents of this manual before use. We also suggest that you take this manual with you to refer to before diving.

Keep this manual in a safe place. If you lose it, contact your original dealer or authorized distributor of our company. A replacement manual will be reissued later.

The main contents consist of the check before use, usage, care after use, storage, and a periodic inspection.

This product is diving gear to use in combination with regulator for recreational diving. Therefore, the knowledge of the right handling of regulator is also necessary. Please use the operating manual of the combination equipment which you use as well as this manual.

In addition, depending on the model of regulator, it is considered not being suitable for the use by the combination with this product. We recommend you use by the combination with the equipment made by Bism.

We are constantly researching and improving our safety second, and so the product you purchased may differ in certain details from the one described in this manual. If you have any queries regarding your safety second or the information contained in this manual, please feel free to contact our company at the address lower right.

CONTENTS

Introduction	1
▲ Important Information	2
Special Features	2
▲ Precautions	3
Names of Parts & Specifications	4 ~ 5
Installation of Various Hoses	6
Check before Use & Setting	6 ~ 7
Basic Usage	8
Care after Use & Storage	9
Periodic Inspection & Service after the Sales	10
Troubleshooting	11

Key to Symbols Used in this Manual

- ▲ Danger Danger indicate a great risk of death or serious injury from improper use.
- ▲ Warning Warning indicate a risk of death or serious injury from improper use.
- ▲ Caution Caution indicate a risk of minor injury or damage to property from improper use.

【Note】 Useful Information to know.

Bism CORPORATION

5F, NF Bldg., Higashinonbashi, Chuo-ku, Tokyo Japan 103-0004
 Phone: +81-3-5640-8126 Fax: +81-3-5640-8131
 E-mail: info@bism.co.jp URL: http://www.bism.co.jp

IMPORTANT INFORMATION

Purpose of Use

This product is diving gear for recreational diving use.

The connection with the regulator allows the use and is a spare breathing apparatus for the second stage of regulator supplying of air in the tank at the time of recreational diving.

Before Use

It is vital to safety that you use and maintain your regulator correctly and have it inspected periodically. Carefully read and understand the advice on safety given in the manuals of this product and also the combination equipment which you use before diving.

- Use only for recreational diving.

⚠ Warning

- Do not use this product for any purpose other than recreational diving

- Obtain C-card before use.

⚠ Warning

- Use this product after having obtained a C-card and completing a proper training program at a recognized diving school, and be familiar with the product, or under the instruction of the diving school. Otherwise it may cause an accident resulting in injury or death.

- Please follow instructions about safety.

⚠ Warning

- When you use this product, please follow all the instructions about the safety directed in this operating manual.

- Do not use if functioning abnormally.

⚠ Warning

- Do not use this product if it is not functioning normally.
- If the product starts to function abnormally, contact your original dealer or authorized distributor of our company. Using a faulty regulator may cause an accident resulting in injury or death.

SPECIAL FEATURES

The Features of this Product

- Adoption of an exclusive plastic hose

The lightweight exclusive plastic hose is adopted as a low-pressure hose. Since it is no odor nature (Food Sanitation Act conformity hose), the air to supply is also clean. In addition, its excellent flexibility also reduces the stress of your mouth.

- Adoption of Double Swivel

Since the second stage and a low-pressure hose are connected by the double swivel mechanism, the 360-degree rotation to back and forth and around is possible for the second stage. As it follows a motion of a diver's face naturally, you can use it comfortably.

- Global standard correspondence of couplings for hose.

End configuration of couplings for hose is changed into the full conformity form of ANSI.Z86.7.2 of the U.S. diving industry standard from the JIS threads.

Junction

- Adoption of Junction Style

B.C. hose integrated spare air supply source.

⚠ PRECAUTIONS

☐ Follow the safety rules.

Only use under the direction of a recognized diving school or after obtaining a C-card having completing a proper training program at a recognized diving school and thoroughly familiarizing yourself with the correct use of a regulator.

Have your buddy double check everything.

Avoid diving deeper than 30m/98ft. (This is the maximum safe depth for normal recreational diving.)

☐ Please use the Bism made hose guard.

Please do not attach hose guards and hose protectors other than our products to a low-pressure hose. It may cause hose breakage.

☐ Do not modify the product.

Since it may become a safety problem, please do not modify the product. Responsibility cannot be taken about the trouble after modification.

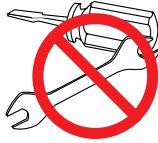

☐ Avoid contact with chemicals.

If mercury and chemicals (thinner, gasoline and various solvents or those cleaner, adhesives, paint, medicine and cosmetics which are containing them) adhere, discoloration and breakage may be occurred on the main body and hoses.



Gasoline

☐ Please use designated grease.

Please apply the designated grease to the designated portion only. Breakage may be caused, if greases other than designated are used or you apply to the portion out of the designation. (Please refer to "Installation of Various Hoses" in the page 9)



Grease

☐ Avoid shocks.

Though the product can withstand the shock in the usual use, drops and hard knocks may damage it.



☐ Do not fold or pull a hose.

⚠ Warning

- Please do not fold or pull a hose. It not only breaks, but it may cause an accident resulting in injury or death.



☐ Do not use it in special environment.

⚠ Warning

- It is a regulator for recreational diving to use in the normal water area (the ocean, a lake, fresh water and seawater swimming pool). You cannot use it in special environment containing a medicine, a solvent, oil, etc.

☐ Do not block up the water pressure sensor hole.

⚠ Warning

- A regulator does not operate normally when the water pressure sensor hole of the first and second stage of a regulator is blocked up. Please do not block up the water pressure sensor hole.



☐ Check the tank to use.

⚠ Warning

- This product is designed to attach to the tank which can fill up 250bar or less with the air in the atmosphere. Therefore, the tank with pure oxygen or high fraction of oxygen cannot be used.



- Please do not use the tank with the fraction of oxygen of greater than 40% for the regulator made out of titanium. Ignition and combustion is generated, and it may cause an accident resulting in injury or death.

NAMES OF PARTS & SPECIFICATIONS

S X 2 3 1 0 K

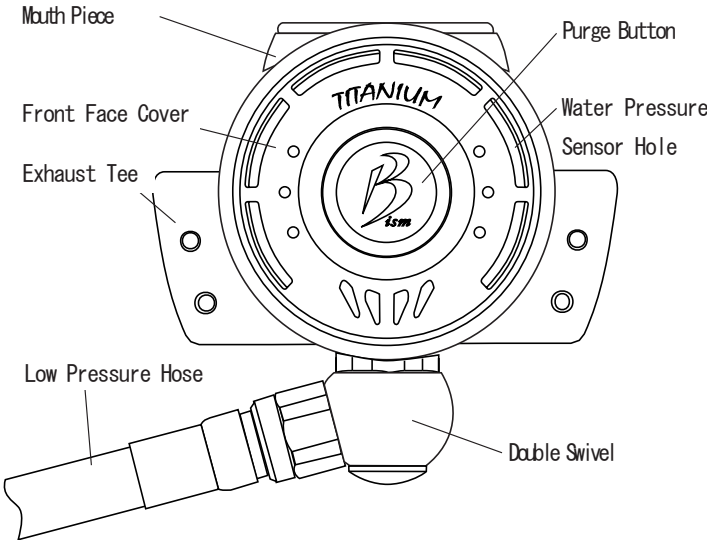
Names of Parts	Specifications
 <p>Mouth Piece</p> <p>Front Face Cover</p> <p>Exhaust Tee</p> <p>Low Pressure Hose</p> <p>Purge Button</p> <p>Water Pressure Sensor Hole</p> <p>Double Swivel</p>	<p>Second Stage</p> <p>Weight (Including Hose)··· 360 g</p> <p>Width of Exhaust Tee····· 90 mm</p> <p>Operation Method········· Combined Use of Diaphragm and Downstream</p> <p>Temperature Range········· + 5 ~ + 50°C</p> <p>Material</p> <p style="padding-left: 40px;">Body Case: POM Plastic</p> <p style="padding-left: 40px;">Face Cover: Pure Titanium</p> <p style="padding-left: 40px;">Mouth Piece: Silicone Rubber</p> <p style="padding-left: 40px;">Valve: Titanium, POM Plastic</p>

S K 2 7 3 0

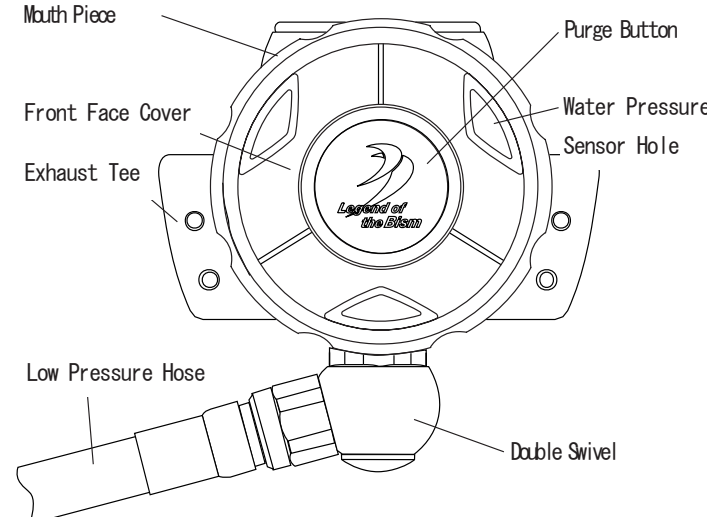
Names of Parts	Specifications
 <p>Mouth Piece</p> <p>Front Face Cover</p> <p>Exhaust Tee</p> <p>Low Pressure Hose</p> <p>Purge Button</p> <p>Water Pressure Sensor Hole</p> <p>Double Swivel</p>	<p>Second Stage</p> <p>Weight (Including Hose)··· 382 g</p> <p>Width of Exhaust Tee····· 90 mm</p> <p>Operation Method········· Combined Use of Diaphragm and Downstream</p> <p>Temperature Range········· + 5 ~ + 50°C</p> <p>Material</p> <p style="padding-left: 40px;">Body Case: POM Plastic</p> <p style="padding-left: 40px;">Face Cover: ABS Plastic</p> <p style="padding-left: 40px;">Mouth Piece: Silicone Rubber</p> <p style="padding-left: 40px;">Valve: Copper Alloy, POM Plastic</p>

S B 2 6 0 0

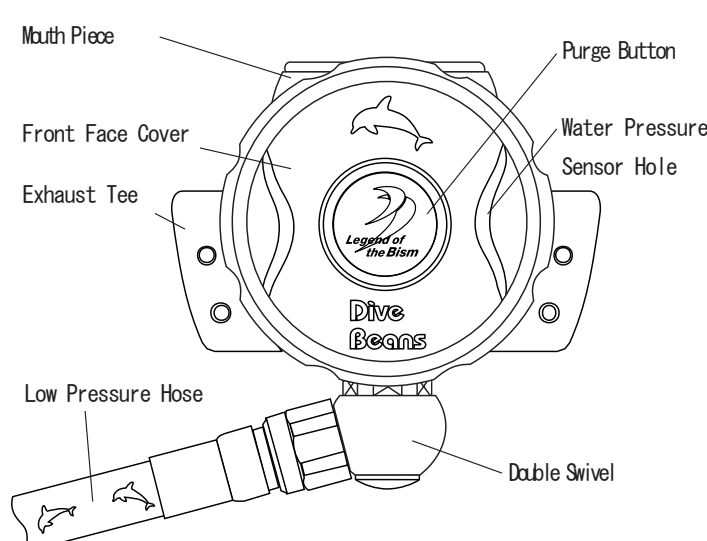
Names of Parts	Specifications
 <p>Mouth Piece</p> <p>Front Face Cover</p> <p>Exhaust Tee</p> <p>Low Pressure Hose</p> <p>Purge Button</p> <p>Water Pressure Sensor Hole</p> <p>Double Swivel</p>	<p>Second Stage</p> <p>Weight (Including Hose)··· 380 g</p> <p>Width of Exhaust Tee····· 90 mm</p> <p>Operation Method········· Combined Use of Diaphragm and Downstream</p> <p>Temperature Range········· + 5 ~ + 50°C</p> <p>Material</p> <p style="padding-left: 40px;">Body Case: POM Plastic</p> <p style="padding-left: 40px;">Face Cover: ABS Plastic</p> <p style="padding-left: 40px;">Mouth Piece: Silicone Rubber</p> <p style="padding-left: 40px;">Valve: Copper Alloy, POM Plastic</p>

NAMES OF PARTS & SPECIFICATIONS

SS 2600

Names of Parts

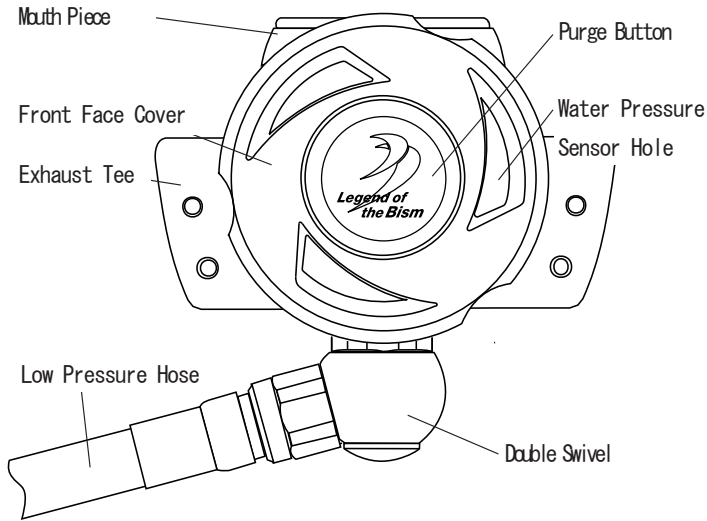

Specifications

Second Stage

Weight (Including Hose)····· 382 g
 Width of Exhaust Tee········· 90 mm
 Operation Method·········· Combined Use of Diaphragm and Downstream
 Temperature Range········· + 5 ~ + 50°C
 Material
 Body Case: POM Plastic
 Face Cover: ABS Plastic
 Mouth Piece: Silicone Rubber
 Valve: Copper Alloy, POM Plastic

Common to SX, SK, SB and SS

Hose Specifications

Hose Length·········· 800 mm
 Outer Diameter·········· 13 mm
 Material of Inner Tube and Outer Cover······ Vinyl Chloride
 Material of Couplings·········· Copper Alloy

 Nominal Size of Coupling Threads········ 3/8-24UNF
 Hose Working Pressure········ 15 bar
 Minimum Bending Radius (Inside of Hose)··· 15 mm
 Hose Guard·········· Regular Equipment
 Material: Elastomer Plastic

SB 2601

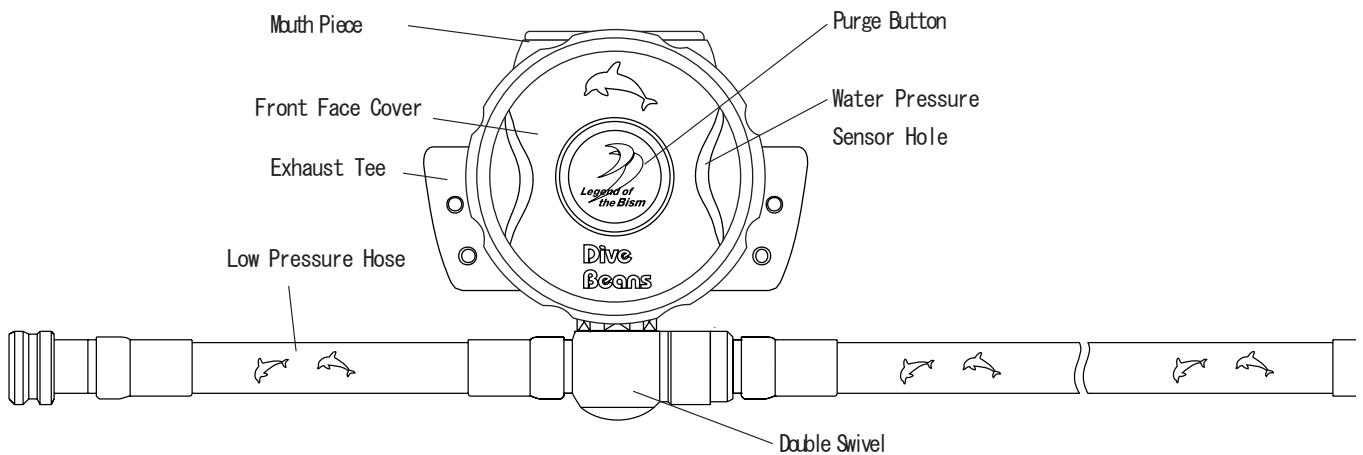

Specifications

Second Stage

Weight (Including Hose)····· 425 g
 Width of Exhaust Tee········ 90 mm
 Operation Method·········· Combined Use of Diaphragm and Downstream
 Temperature Range········· + 5 ~ + 50°C
 Material
 Body Case: POM Plastic
 Face Cover: ABS Plastic
 Mouth Piece: Silicone Rubber
 Valve: Copper Alloy, POM Plastic

Hose Specifications

Hose Length·········· 170 — 550 mm
 Outer Diameter·········· 13 mm
 Material of Inner Tube and Outer Cover······ Vinyl Chloride
 Material of Couplings·········· Copper Alloy

 Nominal Size of Coupling Threads········ 3/8-24UNF
 Hose Working Pressure········ 15 bar
 Minimum Bending Radius (Inside of Hose)··· 15 mm
 Hose Guard·········· Regular Equipment
 Material: Elastomer Plastic

INSTALLATION OF VARIOUS HOSES

⚠ Warning

- Please attach a hose in the state that the first stage of a regulator is not connected to a tank. If the first stage is pressurized during work, a plug in the port flies and it is dangerous.
- Please confirm that O-rings are set at the threads portion of each hose. When there are no O-rings, it causes the air leakage.

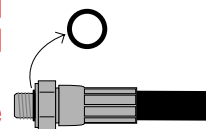

⚠ Caution

- Please ask the authorized distributor of our company for installation of high and low pressure hoses and plugs.
- When you tighten hose couplings with a spanner, please keep the tightening torque (1/36 turns from a tightening start) of $9.8\text{N}\cdot\text{m}$ ($100\text{kgf}\cdot\text{cm}$). Otherwise it may cause to damage the threads portion. In the case of the value of tightening torque listed in the operating manual of a tightened side (gauge, safety second, etc.) is smaller than $9.8\text{N}\cdot\text{m}$, please follow the value.

Installation of Low Pressure Hoses

* Low Pressure Hose: The hose for safety second.

- 1 Please remove the plug from the L.P. port of the first stage of a regulator.

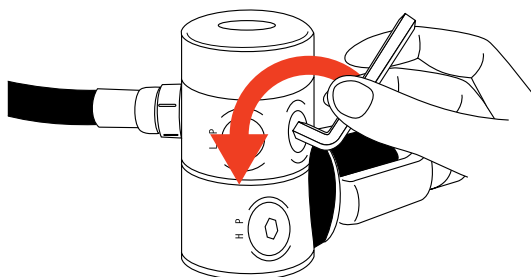

⚠ Warning

- Please install the low pressure hose to an L.P. port, and only the thread size of $3/8-24\text{UNF}$ of low pressure hose couplings should be connected. Otherwise, not only it causes the damage of equipment, but also a hose comes off and it may cause an accident resulting in injury or death.

- 2 Please screw in the coupling of a low pressure hose to L.P. port and turn it clockwise with a spanner to tighten it. Tightening torque is $9.8\text{N}\cdot\text{m}$ ($100\text{kgf}\cdot\text{m}$).

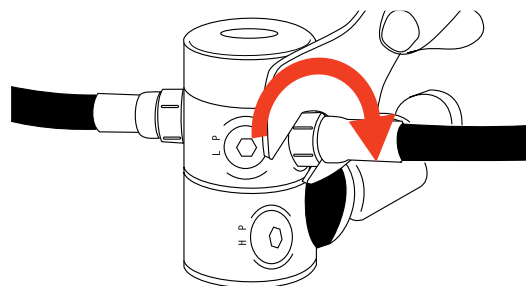

CHECK BEFORE USE & SETTING

⚠ Warning

- If there is an abnormality in your regulator by following various checks, you must not use it.
- When there is an abnormality, contact your original dealer or authorized distributor of our company. Use of the regulator which is not normal may cause an accident resulting in injury or death.

- 1 Check of the hoses.

Before setting your regulator to a tank valve, please check whether the hose is damaged or has not broken. All the hoses, such as a hose of the safety second connected to the first stage and a high pressure hose, are to be checked.

- 2 Check of the second stage.

⚠ Warning

- Please check whether the face cover is tightened enough. If not, please retighten it.



Check if there is any crack in each part of the second stage by visual.

CHECK BEFORE USE & SETTING (Continued)

3 Setting the regulator to a tank.

⚠ Warning

- Please open a tank valve after checking that the regulator is set to a tank in the right direction, and that the yoke screw is tightened firmly.
- Please open the tank valve slowly.



⚠ Caution

- Please do not tighten a yoke screw too much strongly. It may be unable to take off after use.

- (1) Check that the O-ring is attached to the tank valve.
- (2) Making the direction of the second stage of a regulator so as it comes out of a right shoulder, and put a yoke so that the end connection of the first stage of a regulator may suit the groove of the O-ring of the tank valve.
- (3) Turn a yoke screw to the right, and tighten it until the end connection stops shaking.

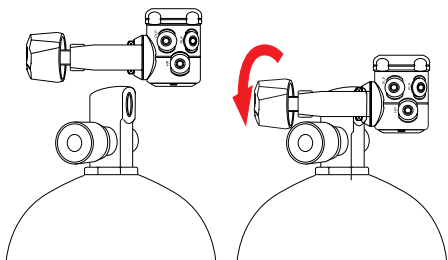

- (4) Before opening the tank valve, please hold a mouthpiece in your mouth and inhale air to check if the air does not leak and does not come in to your mouth.
- (5) Open the tank valve slowly and once it gets to full open, return by half-rotation.

[Note]

○ A tank valve also has a kind. The question about a tank valve should read the operating manual of the tank valve.

4 Connect a quick-coupler to inflator. (In the case of junction)

⚠ Warning

- When you perform the connecting work of a quick-coupler, close the tank valve, depress the purge button of a regulator to release the pressurized air in a hose.

- (1) Connect a quick-coupler to a nose of B.C. inflator while sliding a collar of the quick-coupler.

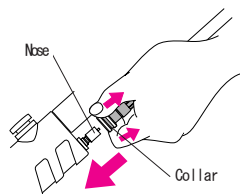

- (2) Grip the end of the quick-coupler and push it until it sounds "click".

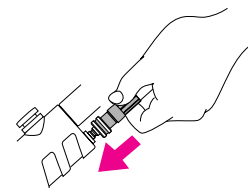

- (3) While pulling the quick-coupler by gripping the end of it, check whether it comes off. When it comes off, please start it again from the beginning.

5 Check of the air leakage.

- (1) Before opening the tank valve, please hold a mouthpiece in your mouth and inhale air to check if the air does not leak and does not come in to your mouth.

- (2) Open the tank valve slowly and once it gets to full open, return by half-rotation.

- (3) Check if there is any air leakage on the first and second stage of regulator, connecting portion of hose and hose itself.

- (4) When air leaks from connecting portion to inflator (around the quick-coupler), close the valve, release the residual pressure in a hose by depressing purge button of a regulator second stage, and then install the quick-coupler again recheck the air leakage.

(If air still leaks, stop to use it and consult with your original dealer or authorized distributor of our company.)

6 Check of the air intake and exhaust.

⚠ Warning

- After setting, when air does not come out from the second stage of the regulator normally, please do not use it.
- When the inhaled air has a smell, please stop to use the tank and change for other tanks. When the air still has a smell even if you change a tank, please stop to use the regulator.

Please hold a mouthpiece in your mouth, breathe with a mouth 4 ~ 5 times, and check that air flows normally.

How to Hold a Mouthpiece in Your Mouth.

⚠ Caution

- Please do not bite the projection portion of a mouthpiece strongly. You may cut it off, if you bite strongly.

Bite the projection portion of a mouthpiece lightly with your teeth, and hold it in your mouth so that the whole may be covered with lips..

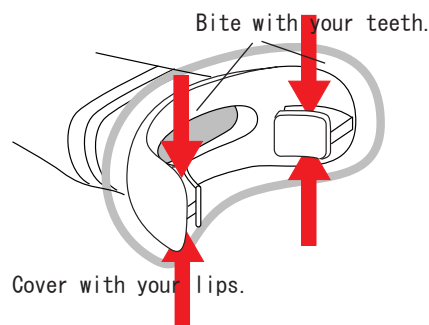

BASIC USAGE

How to Hold a Mouthpiece

⚠ Warning

- Please do not bite the projection portion of a mouthpiece strongly. Otherwise, as you may cut it off, and there is a possibility of becoming easy to separate from a mouth which leads to be drowned, thus it may cause an accident resulting in injury or death.
- Please hold the second stage in your mouth so that a hose installed portion comes to a lower position.

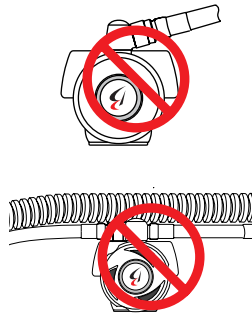

Hold it in your mouth so that a mouthpiece comes to an upper position and a hose comes to a lower position.

Breathing

【Note】

○ While breathing, if a face cover side of a regulator is turned to the surface, breathing resistance will increase.



After holding a mouthpiece in your mouth and performing regulator clear, breathe with your mouth deeply and slowly.

Regulator Clearing

⚠ Warning

- Please be sure to breathe, after draining by performing regulator clearing before inhaling air. It may cause drowning by drinking water accidentally.
- If it carries out in the state that regulator clearing is not mastered, it may cause drowning by drinking water. Please perform practice of regulator clear under instruction of a diving school.

Before inhaling air, perform discharge operation of water which entered in the second stage of a regulator. (Regulator Clear)

■ Regulator Clearing with the Purge Button.

In the state of holding a mouthpiece in your mouth, depress the purge button while exhaling.

Since water may remain, inhale air slowly so that you may not drink water, and if the water still remains carry out the same once again.

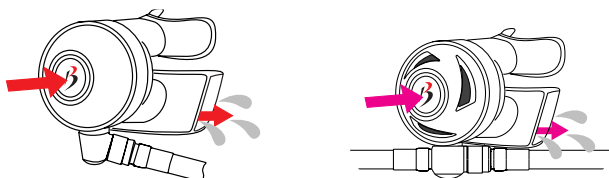

If a Free Flow is Carried Out . . .

⚠ Caution

- Although a free flow may be carried out from the second stage of a regulator immediately after an entry, if you cannot stop it by the method explained below, please stop use.



▼ Please plug up the hole of a mouthpiece with a palm or a finger.

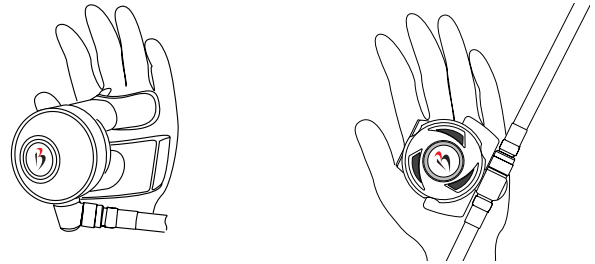

▼ Turn mouthpiece downward underwater.

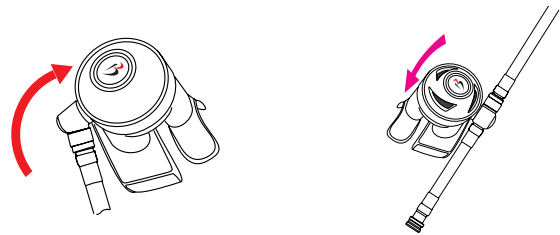

【Note】

○ By the direction of second stage, such as immediately after an entry, air may blow off from a mouthpiece portion. It is not failure when it stops by the above mentioned method.

【Note】 ○ Water can be effectively discharged by taking an upward slanting posture.

CARE AFTER USE & STORAGE

Removal from a Tank.

⚠ Caution

- Please be sure to release the compressed air in a regulator, before working to remove the first stage of a regulator from a tank valve. If it is not released, it may lead an explosion and cause an accident resulting in injury or death.

- 1 Close a tank valve.
- 2 Push a purge button to release the air inside a regulator completely.

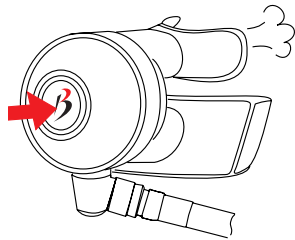

- 3 Loosen yoke screw and remove a regulator.

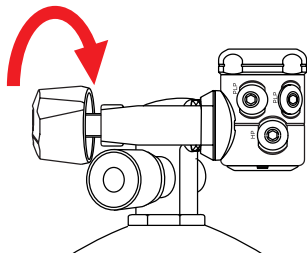

- 4 After removing the water of the dust cap enough with an air blow or a towel, turn a yoke screw and fix to the connecting portion of the first stage of a regulator firmly.

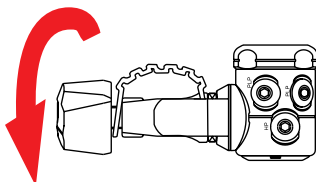
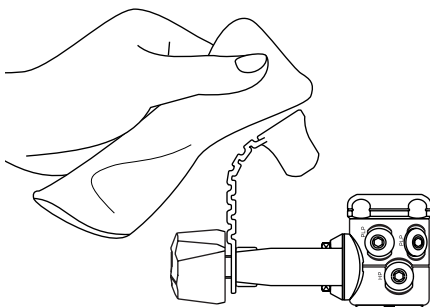

Disconnect Quick-Coupler from B.C. Inflator. (In the case of junction)

⚠ Caution

- Before disconnecting a quick-coupler of B.C. hose from inflator, be sure to close the tank valve, depress the purge button of a regulator to release the pressurized air in a hose.

- 1 According to the operating manual of a regulator and a tank for SCUBA diving, close the tank valve.
- 2 Depress the purge button of regulator second stage to release residual air in a hose.
- 3 Pull the collar of a quick-coupler and disconnect from the nose as it is.

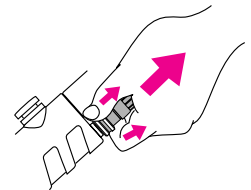

Wash

⚠ Caution

- Equipment may be damaged if soaked in hot water of 50°C or more.
- Please do not push purge button of the second stage of a regulator by any means during washing. Water comes in and may cause the trouble.
- Please be sure to put the dust cap of the first stage of a regulator firmly. Otherwise water comes in the gauge and hose, and it causes failure.

Soak the whole equipment to fresh water for about 15 minutes in the state of being set with the regulator. Then, rinse the whole in water to wash the salt away.

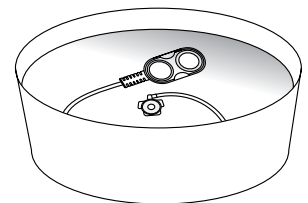

Pour water on the groove portions of mouthpiece and face of second stage, and rinse them.

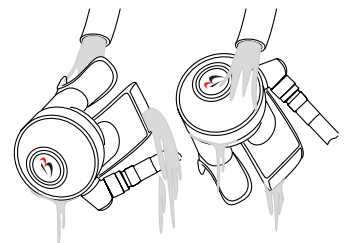

【Note】

- When you push the purge button of the second stage of a regulator by accident during washing, connect the first stage to a tank again and push the purge button to blow off internal water. Then, contact your original dealer or authorized distributor of our company.

PERIODIC INSPECTION & SERVICE AFTER THE SALES

Drying-Out and Storage

⚠ Caution

- Please keep the hose in a natural form. Forced bending causes kinking of a hose and shorten a hose life remarkably.
- If you leave a regulator in the state of high temperature, such as in a car or on a beach, it may interfere with a function.
- When a translucent mouthpiece and white parts (hose etc.) are left under sunlight or a fluorescent light for a long time, it may yellow. Moreover, if they touch rubber commodities, such as a fin, for a long time, a color of the rubber may stain.



- Wash and dry a regulator fully.
- Avoid direct rays, and store a regulator after making it fully dry in the shade with the dry, cool and sufficient ventilation.

Periodic Inspection

⚠ Caution

- Please ask your original dealer or authorized distributor of our company for a periodic inspection per once in a year or once in every 100 dives.
- Regardless whether or not you use it, regulator may not function normally when you ignore a periodic inspection.

【Note】

- Some parts carry out natural deterioration. Exchange of such parts is also performed by periodic check.
- Please ask your original dealer or authorized distributor of our company for a periodic inspection per once in a year. (Pay Service)

Service after the Sales

- When your regulator is out of condition, check it first.

Please refer to the clause of "Troubleshooting" and check whether it is failure.

- When it is still out of order;

Please contact your original dealer or authorized distributor of our company.

- Reserving period of parts.

Our company reserves the performance parts (the parts required to maintain the function of the product) for repairing a regulator for at least 8 years after the production is discontinued. Since repair may be possible depending on a problem even after this reserving period passes, please consult with your original dealer or authorized distributor of our company.

TROUBLESHOOTING

Please check it once again before sending it to repair. When still not operating normally, please consult with your original dealer or authorized distributor of our company for repair.

Trouble	Major Cause	Measure	Page
Air does not flow.	<ul style="list-style-type: none"> ○ A failure to open the cock of a tank valve. ○ A tank is empty. ○ Water pressure sensor hole of either first stage or second stage is blocked 	<ul style="list-style-type: none"> ○ Open the tank valve. ○ Change to a tank with full of air. ○ Check whether the water pressure sensor hole is blocked. 	<p>7</p> <p>7</p> <p>3</p>
Inhalation resistance is high.	<ul style="list-style-type: none"> ○ There is little air in a tank. ○ Tank valve is not fully opened. ○ Operation failure of the second stage. ○ Water pressure sensor hole of either first stage or second stage is blocked. 	<ul style="list-style-type: none"> ○ Change to a tank with full of air. ○ Make a tank valve full open. ○ Consult with your original dealer or authorized distributor of our company ○ Check whether the water pressure sensor hole is blocked. 	<p>7</p> <p>7</p> <p>—</p> <p>3</p>
Exhalation resistance is high.	<ul style="list-style-type: none"> ○ Fixing of body case and exhaust valve. 	<ul style="list-style-type: none"> ○ Dip in water and melt the crystal of salt. 	<p>9</p>
Free flow	<ul style="list-style-type: none"> ○ Air is blow off by Venturi effect. 	<ul style="list-style-type: none"> ○ Block the hole of mouthpiece, or face it downward. 	<p>8</p>
Water comes in to the second stage.	<ul style="list-style-type: none"> ○ Regulator clear is not enough. ○ A foreign substance is caught in an exhaust valve. ○ Slack and crack of a mouthpiece. ○ Crack of a second body case. 	<ul style="list-style-type: none"> ○ Perform the regulator clear again. ○ Check of the exhaust valve. ○ Check of a mouthpiece. ○ Consult with your original dealer or authorized distributor of our company 	<p>8</p> <p>—</p> <p>—</p> <p>—</p>
Air leakage from the first stage.	<ul style="list-style-type: none"> ○ Thread portion of a hose loosen or comes off. ○ Abrasion of O-ring of an air leak portion, a crack and a foreign substance. 	<ul style="list-style-type: none"> ○ Retighten the thread portion of all hose. ○ Consult with your original dealer or authorized distributor of our company 	<p>6</p> <p>—</p>

